

# PCS

## SECTION

### POWER CONTROL SYSTEM

A  
B  
C

## CONTENTS

<b>IPDM E/R</b>		
<b>BASIC INSPECTION</b> .....	<b>B2099 IGNITION RELAY OFF STUCK</b> .....	F
4	Description .....	21
<b>DIAGNOSIS AND REPAIR WORKFLOW</b> .....	DTC Logic .....	21
4	Diagnosis Procedure .....	21
Work Flow .....	<b>POWER SUPPLY AND GROUND CIRCUIT</b> ....	G
4	Diagnosis Procedure .....	22
<b>FUNCTION DIAGNOSIS</b> .....	<b>ECU DIAGNOSIS</b> .....	H
7	23	
<b>RELAY CONTROL SYSTEM</b> .....	<b>IPDM E/R (INTELLIGENT POWER DISTRI-</b>	I
7	<b>BUTION MODULE ENGINE ROOM)</b> .....	23
System Diagram .....	Reference Value .....	23
7	Wiring Diagram .....	31
System Description .....	Fail Safe .....	36
8	DTC Index .....	38
Component Parts Location .....	<b>PRECAUTION</b> .....	K
9	39	
<b>POWER CONTROL SYSTEM</b> .....	<b>PRECAUTIONS</b> .....	L
10	39	
System Diagram .....	Precaution for Supplemental Restraint System	
10	(SRS) "AIR BAG" and "SEAT BELT PRE-TEN-	
System Description .....	SIONER" .....	39
10	Precautions Necessary for Steering Wheel Rota-	
<b>SIGNAL BUFFER SYSTEM</b> .....	tion after Battery Disconnect (Early Production,	
11	With Electronic Steering Column Lock) .....	39
System Diagram .....	Precaution for Procedure without Cowl Top Cover...	40
11		
System Description .....	<b>ON-VEHICLE REPAIR</b> .....	N
11	41	
<b>POWER CONSUMPTION CONTROL SYS-</b>	<b>IPDM E/R (INTELLIGENT POWER DISTRI-</b>	O
<b>TEM</b> .....	<b>BUTION MODULE ENGINE ROOM)</b> .....	41
12	Removal and Installation .....	41
System Diagram .....	<b>POWER DISTRIBUTION SYSTEM</b>	
12		
System Description .....	<b>BASIC INSPECTION</b> .....	P
12	42	
Component Parts Location .....	<b>DIAGNOSIS AND REPAIR WORKFLOW</b> .....	42
13	Work Flow .....	42
<b>DIAGNOSIS SYSTEM (IPDM E/R)</b> .....	Pre-Inspection for Multi-System Diagnostic .....	44
14		
Diagnosis Description .....	<b>FUNCTION DIAGNOSIS</b> .....	46
14		
CONSULT - III Function (IPDM E/R) .....		
16		
<b>COMPONENT DIAGNOSIS</b> .....		
19		
<b>U1000 CAN COMM CIRCUIT</b> .....		
19		
Description .....		
19		
DTC Logic .....		
19		
Diagnosis Procedure .....		
19		
<b>B2098 IGNITION RELAY ON STUCK</b> .....		
20		
Description .....		
20		
DTC Logic .....		
20		
Diagnosis Procedure .....		
20		

PCS

<b>POWER DISTRIBUTION SYSTEM</b> .....	<b>46</b>	DTC Logic .....	69
System Description .....	46	Diagnosis Procedure .....	69
Component Parts Location .....	47		
Component Description .....	48		
<b>DIAGNOSIS SYSTEM (BCM)</b> .....	<b>49</b>	<b>POWER SUPPLY AND GROUND CIRCUIT</b> ....	<b>72</b>
<b>COMMON ITEM</b> .....	<b>49</b>	<b>BCM</b> .....	<b>72</b>
COMMON ITEM : CONSULT-III Function .....	49	BCM : Diagnosis Procedure .....	72
<b>INTELLIGENT KEY</b> .....	<b>49</b>	<b>IPDM E/R (INTELLIGENT POWER DISTRIBUTION MODULE ENGINE ROOM)</b> .....	<b>73</b>
INTELLIGENT KEY : CONSULT-III Function (BCM - INTELLIGENT KEY) .....	49	IPDM E/R (INTELLIGENT POWER DISTRIBUTION MODULE ENGINE ROOM) : Diagnosis Procedure .....	73
<b>COMPONENT DIAGNOSIS</b> .....	<b>53</b>	<b>PUSH-BUTTON IGNITION SWITCH POSITION INDICATOR</b> .....	<b>75</b>
<b>U1000 CAN COMM CIRCUIT</b> .....	<b>53</b>	Description .....	75
Description .....	53	Component Function Check .....	75
DTC Logic .....	53	Diagnosis Procedure .....	75
Diagnosis Procedure .....	53	Component Inspection .....	77
<b>U1010 CONTROL UNIT (CAN)</b> .....	<b>54</b>	<b>ECU DIAGNOSIS</b> .....	<b>78</b>
DTC Logic .....	54	<b>BCM (BODY CONTROL MODULE)</b> .....	<b>78</b>
Diagnosis Procedure .....	54	Reference Value .....	78
<b>B2553 IGNITION RELAY</b> .....	<b>55</b>	Terminal Layout .....	83
Description .....	55	Physical Values .....	83
DTC Logic .....	55	Wiring Diagram .....	101
Diagnosis Procedure .....	55	Fail Safe .....	109
<b>B260A IGNITION RELAY</b> .....	<b>57</b>	DTC Inspection Priority Chart .....	111
Description .....	57	DTC Index .....	113
DTC Logic .....	57	<b>IPDM E/R (INTELLIGENT POWER DISTRIBUTION MODULE ENGINE ROOM)</b> .....	<b>115</b>
Diagnosis Procedure .....	57	Reference Value .....	115
<b>B2614 ACC RELAY CIRCUIT</b> .....	<b>59</b>	Wiring Diagram .....	123
Description .....	59	Fail Safe .....	129
DTC Logic .....	59	DTC Index .....	131
Diagnosis Procedure .....	59	<b>SYMPTOM DIAGNOSIS</b> .....	<b>132</b>
Component Inspection (Accessory Relay) .....	61	<b>POWER DISTRIBUTION SYSTEM SYMPTOMS</b> .....	<b>132</b>
<b>B2615 FRONT BLOWER MOTOR RELAY CIRCUIT</b> .....	<b>62</b>	Symptom Table .....	132
Description .....	62	<b>PRECAUTION</b> .....	<b>133</b>
DTC Logic .....	62	<b>PRECAUTIONS</b> .....	<b>133</b>
Diagnosis Procedure .....	62	Precaution for Supplemental Restraint System (SRS) "AIR BAG" and "SEAT BELT PRE-TENSIONER" .....	133
Component Inspection (Front Blower Motor Relay) .....	64	Precautions Necessary for Steering Wheel Rotation after Battery Disconnect (Early Production, With Electronic Steering Column Lock) .....	133
<b>B2616 IGNITION RELAY CIRCUIT</b> .....	<b>65</b>	Precaution for Procedure without Cowl Top Cover. ....	134
Description .....	65	<b>ON-VEHICLE REPAIR</b> .....	<b>135</b>
DTC Logic .....	65	<b>BCM (BODY CONTROL MODULE)</b> .....	<b>135</b>
Diagnosis Procedure .....	65	Removal and Installation .....	135
Component Inspection (Ignition Relay) .....	67	<b>PUSH BUTTON IGNITION SWITCH</b> .....	<b>136</b>
<b>B2618 BCM</b> .....	<b>68</b>		
Description .....	68		
DTC Logic .....	68		
Diagnosis Procedure .....	68		
<b>B261A PUSH-BUTTON IGNITION SWITCH</b> ....	<b>69</b>		
Description .....	69		

A

B

C

D

E

F

G

H

I

J

K

L

**PCS**

N

O

P

# DIAGNOSIS AND REPAIR WORKFLOW

< BASIC INSPECTION >

[IPDM E/R]

## BASIC INSPECTION

### DIAGNOSIS AND REPAIR WORKFLOW

Work Flow

INFOID:000000005460579

OVERALL SEQUENCE

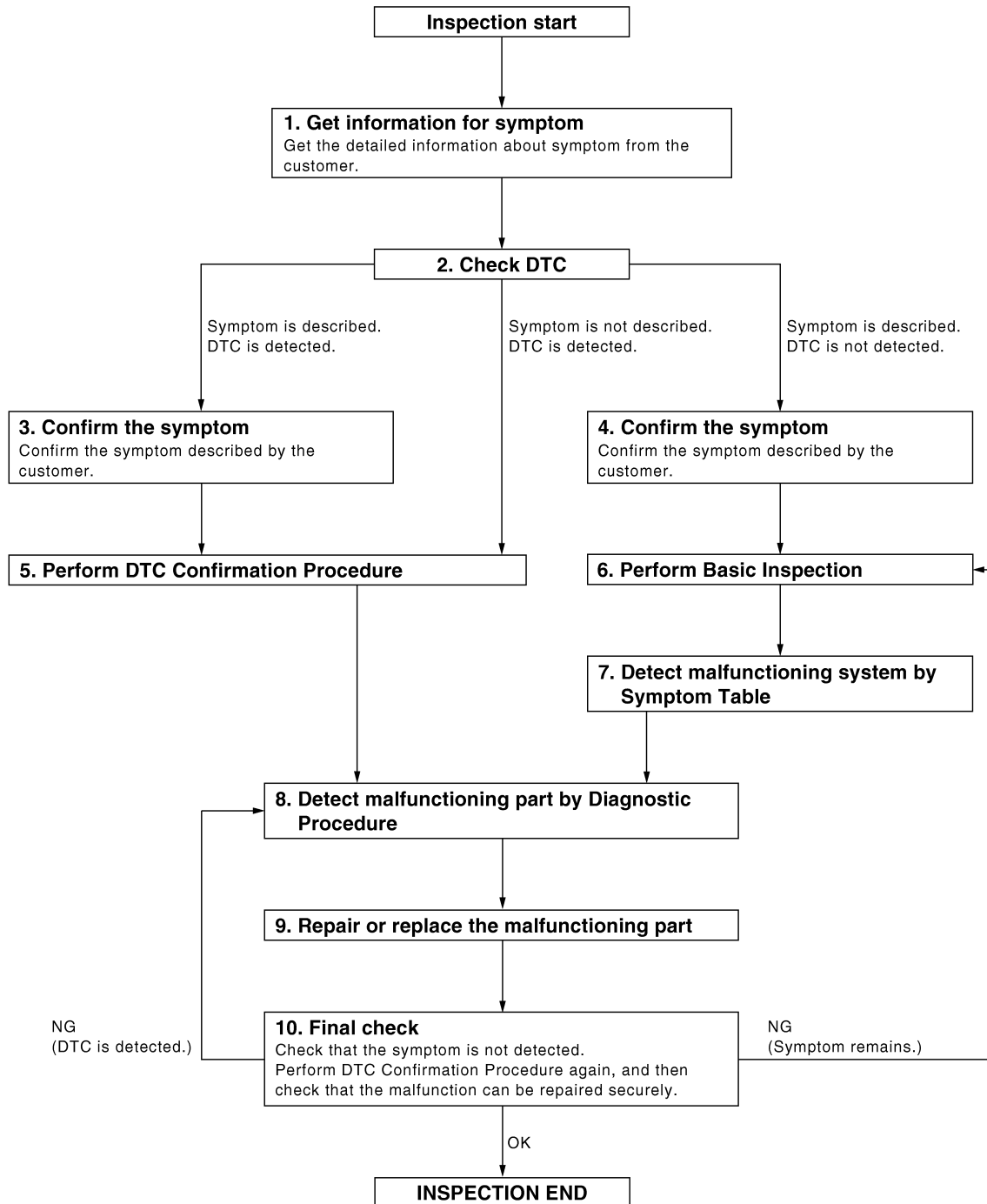

DETAILED FLOW

JMKIA0101GB

# DIAGNOSIS AND REPAIR WORKFLOW

< BASIC INSPECTION >

[IPDM E/R]

## 1. GET INFORMATION FOR SYMPTOM

Get the detailed information from the customer about the symptom (the condition and the environment when the incident/malfunction occurred).

>> GO TO 2

## 2. CHECK DTC

1. Check DTC.
2. Perform the following procedure if DTC is displayed.
  - Record DTC and freeze frame data (Print them out with CONSULT-III.)
  - Erase DTC.
  - Study the relationship between the cause detected by DTC and the symptom described by the customer.
3. Check related service bulletins for information.

Is any symptom described and any DTC detected?

Symptom is described, DTC is displayed>>GO TO 3

Symptom is described, DTC is not displayed>>GO TO 4

Symptom is not described, DTC is displayed>>GO TO 5

## 3. CONFIRM THE SYMPTOM

Confirm the symptom described by the customer.

Connect CONSULT-III to the vehicle in "DATA MONITOR" mode and check real time diagnosis results. Verify relationship between the symptom and the condition when the symptom is detected.

>> GO TO 5

## 4. CONFIRM THE SYMPTOM

Confirm the symptom described by the customer.

Connect CONSULT-III to the vehicle in "DATA MONITOR" mode and check real time diagnosis results. Verify relationship between the symptom and the condition when the symptom is detected.

>> GO TO 6

## 5. PERFORM DTC CONFIRMATION PROCEDURE

Perform DTC Confirmation Procedure for the displayed DTC, and then check that DTC is detected again. At this time, always connect CONSULT-III to the vehicle, and check diagnostic results in real time.

If two or more DTCs are detected, refer to [PCS-111, "DTC Inspection Priority Chart"](#) and determine trouble diagnosis order.

### NOTE:

- Freeze frame data is useful if the DTC is not detected.
- Perform Component Function Check if DTC Confirmation Procedure is not included in Service Manual. This simplified check procedure is an effective alternative although DTC cannot be detected during this check. If the result of Component Function Check is NG, it is the same as the detection of DTC by DTC Confirmation Procedure.

Is DTC detected?

YES >> GO TO 8

NO >> Refer to [GI-39, "Intermittent Incident"](#).

## 6. PERFORM BASIC INSPECTION

Perform a basic inspection of the IPDM E/R.

Inspection End>>GO TO 7

## 7. DETECT MALFUNCTIONING SYSTEM BY SYMPTOM TABLE

Detect malfunctioning system according to [PCS-132, "Symptom Table"](#) based on the confirmed symptom in step 4, and determine the trouble diagnosis order based on possible causes and symptom.

>> GO TO 8

A  
B  
C  
D  
E  
F  
G  
H  
I  
J  
K  
L

PCS

N  
O  
P

# DIAGNOSIS AND REPAIR WORKFLOW

[IPDM E/R]

< BASIC INSPECTION >

---

## 8. DETECT MALFUNCTIONING PART BY DIAGNOSTIC PROCEDURE

---

Inspect according to Diagnostic Procedure of the system.

**NOTE:**

The Diagnostic Procedure described is based on open circuit inspection. A short circuit inspection is also required for the circuit check in the Diagnostic Procedure.

Is malfunctioning part detected?

YES >> GO TO 9

NO >> Check voltage of related BCM terminals using CONSULT-III.

---

## 9. REPAIR OR REPLACE THE MALFUNCTIONING PART

---

1. Repair or replace the malfunctioning part.
2. Reconnect parts or connectors disconnected during Diagnostic Procedure again after repair and replacement.
3. Check DTC. If DTC is displayed, erase it.

>> GO TO 10

---

## 10. FINAL CHECK

---

When DTC was detected in step 2, perform DTC Confirmation Procedure or Component Function Check again, and then check that the malfunction have been fully repaired.

When symptom was described from the customer, refer to confirmed symptom in step 3 or 4 and check that the symptom is not detected.

Is the inspection result normal?

YES >> Inspection End.

NO (DTC is detected)>>GO TO 8

NO (Symptom remains)>>GO TO 6

# RELAY CONTROL SYSTEM

< FUNCTION DIAGNOSIS >

[IPDM E/R]

## FUNCTION DIAGNOSIS

### RELAY CONTROL SYSTEM

#### System Diagram

INFOID:000000005460580

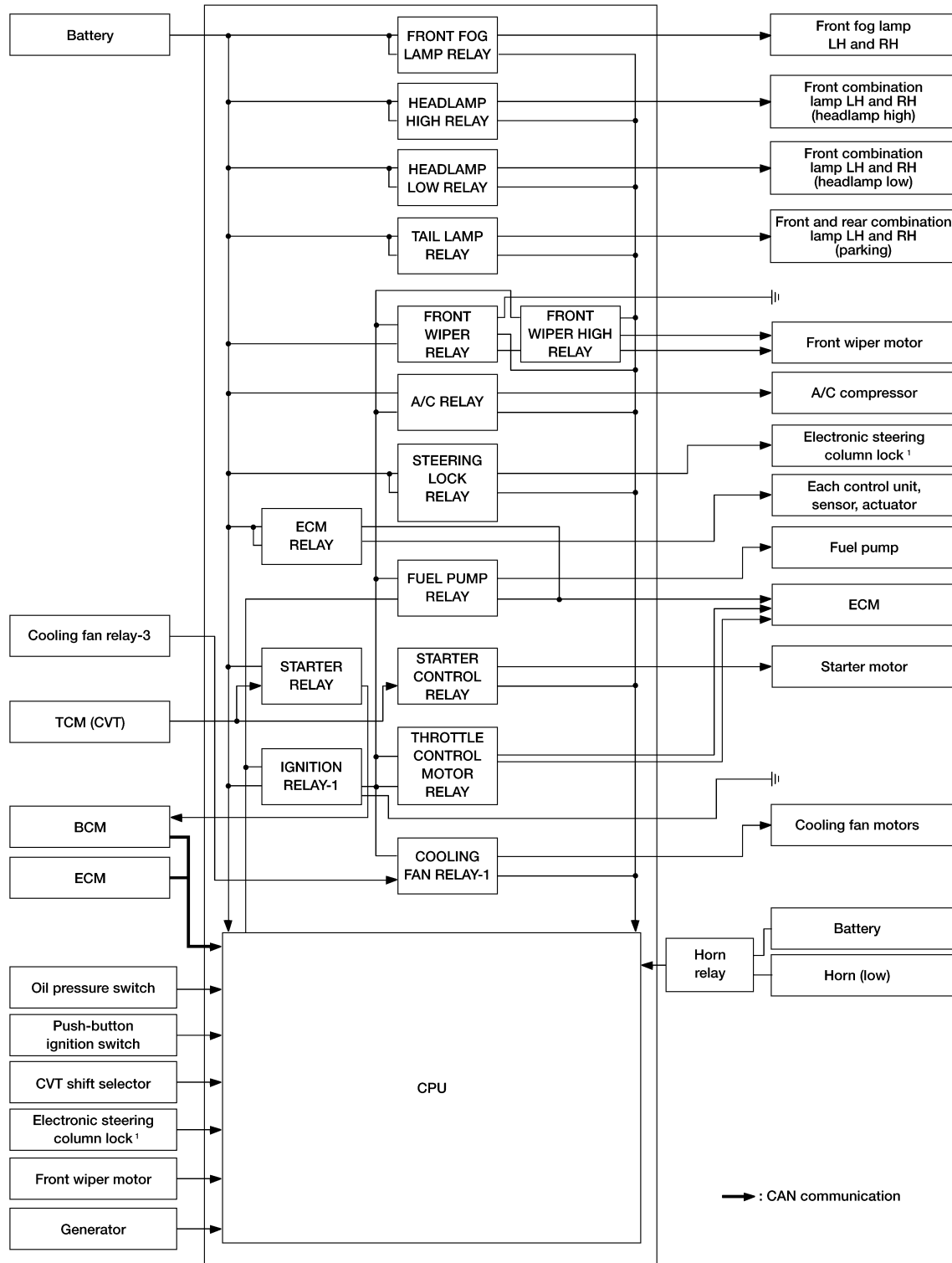

1: Early production

AWMIA1177GB

A  
B  
C  
D  
E  
F  
G  
H  
I  
J  
K  
L  
PCS  
N  
O  
P

# RELAY CONTROL SYSTEM

< FUNCTION DIAGNOSIS >

[IPDM E/R]

## System Description

INFOID:000000005460581

IPDM E/R activates the internal control circuit to perform the relay ON-OFF control according to the input signals from various sensors and the request signals received from control units via CAN communication.

### CAUTION:

**IPDM E/R integrated relays cannot be removed.**

Control relay	Input/output	Transmit unit	Control part	Reference page
<ul style="list-style-type: none"> <li>Headlamp low relay</li> <li>Headlamp high relay</li> </ul>	<ul style="list-style-type: none"> <li>Low beam request signal</li> <li>High beam request signal</li> </ul>	BCM (CAN)	<ul style="list-style-type: none"> <li>Headlamp low</li> <li>Headlamp high</li> </ul>	<a href="#">EXL-39</a> , <a href="#">EXL-213</a> (with xenon head-lamps) <a href="#">EXL-37</a> , <a href="#">EXL-211</a> (with halogen head-lamps)
Front fog lamp relay (if equipped)	Front fog light request signal	BCM (CAN)	Front fog lamp	<a href="#">EXL-41</a> , (with xenon head-lamps) <a href="#">EXL-189</a> , (with halogen head-lamps)
Tail lamp relay	Position light request signal	BCM (CAN)	<ul style="list-style-type: none"> <li>Parking lamp</li> <li>License plate lamp</li> <li>Tail lamp</li> <li>Illuminations</li> </ul>	<a href="#">EXL-83</a> , (with xenon head-lamps) <a href="#">EXL-193</a> , (with halogen head-lamps)
<ul style="list-style-type: none"> <li>Front wiper relay</li> <li>Front wiper high relay</li> </ul>	Front wiper request signal Front wiper auto stop signal	BCM (CAN) Front wiper motor	Front wiper	<a href="#">WW-19</a>
<ul style="list-style-type: none"> <li>Starter relay<sup>1</sup></li> <li>Starter control relay</li> </ul>	Starter control relay signal Starter relay control signal	BCM (CAN) TCM	Starter motor	<a href="#">STR-5</a> ,
Steering lock relay <sup>2</sup>	Steering lock relay signal	BCM (CAN)	Electronic steering column lock	<a href="#">SEC-11</a>
	Electronic steering column lock condition signal	Electronic steering column lock		
	CVT shift selector (park position switch) signal	CVT shift selector (park position switch) signal		
A/C relay	A/C compressor request signal	ECM (CAN)	A/C compressor (magnet clutch)	<a href="#">HAC-61</a> (with color display) or <a href="#">HAC-186</a> (with monochrome display)
Ignition relay - 1	Ignition switch ON signal	BCM (CAN)	Ignition relay - 1	<a href="#">BCS-8</a>
	Vehicle speed signal	Combination meter (CAN)		
	Push-button ignition switch	Push-button ignition switch		
Fuel pump relay	Fuel pump request signal	ECM	Fuel pump	<a href="#">EC-479</a>
ECM relay	ECM relay control signal	ECM	ECM relay	<a href="#">EC-144</a>



# RELAY CONTROL SYSTEM

< FUNCTION DIAGNOSIS >

[IPDM E/R]

Control relay	Input/output	Transmit unit	Control part	Reference page
Throttle control motor relay	Throttle control motor relay signal	ECM	Throttle control motor relay	<a href="#">EC-433</a>
Cooling fan relay - 1	Cooling fan request signal	ECM (CAN)	Cooling fan relay 1	<a href="#">EC-466</a>

1: BCM controls the starter relay.

2: Early production

## Component Parts Location

INFOID:000000005460582

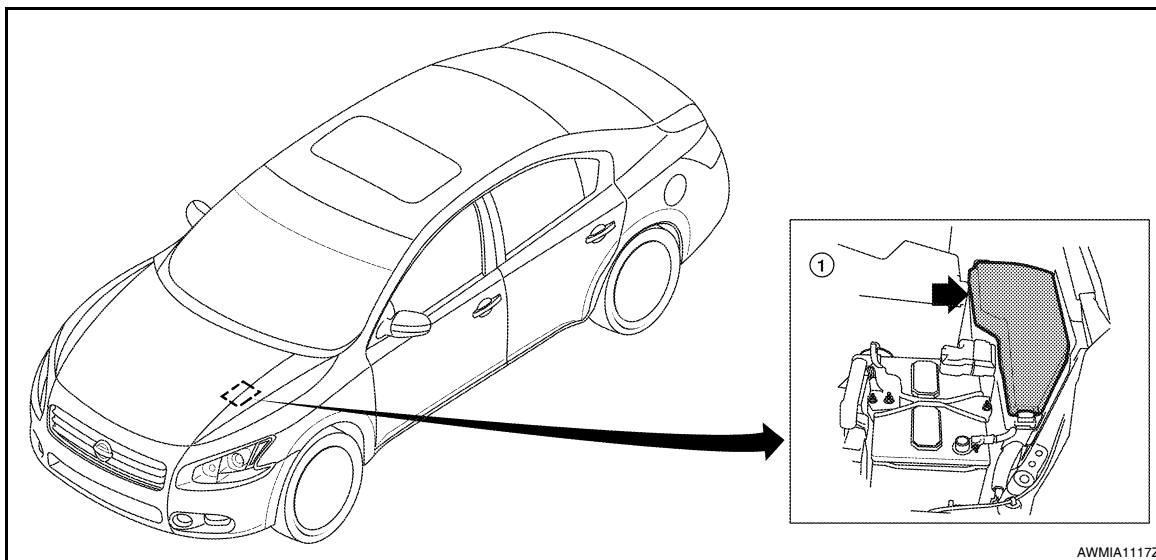

1. IPDM E/R E16, E17, E18, E200, E201, F10

PCS

## POWER CONTROL SYSTEM

### System Diagram

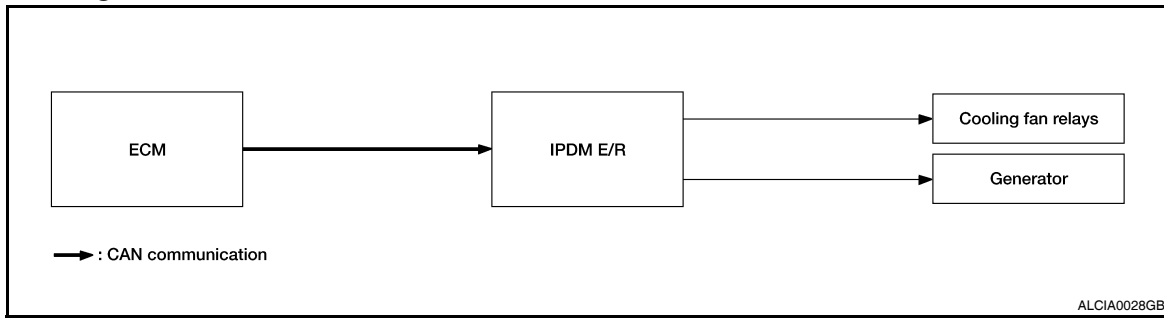

### System Description

INFOID:000000005460584

#### COOLING FAN CONTROL

IPDM E/R controls cooling fans according to the status of the cooling fan speed request signal received from ECM via CAN communication.

#### GENERATOR CONTROL

IPDM E/R outputs power generation command signal (PWM signal) to the generator according to the status of the power generation command value signal received from ECM via CAN communication. Refer to [STR-5](#), "[System Description](#)".

## SIGNAL BUFFER SYSTEM

### System Diagram

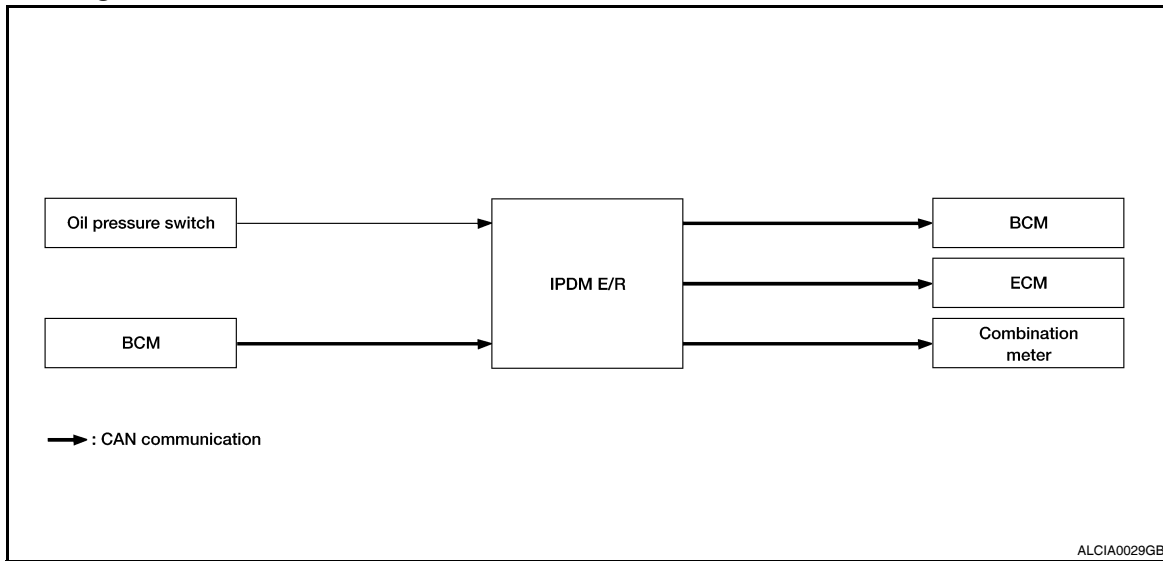

### System Description

INFOID:000000005460586

- IPDM E/R reads the status of the oil pressure switch and transmits the oil pressure switch signal to BCM via CAN communication. Refer to [PCS-11, "System Description"](#).
- IPDM E/R receives the rear window defogger status signal from BCM via CAN communication and transmits it to ECM via CAN communication. Refer to [PCS-11, "System Description"](#).

A  
B  
C  
D  
E  
F  
G  
H  
I  
J  
K  
L  
N  
O  
P

PCS

## POWER CONSUMPTION CONTROL SYSTEM

### System Diagram

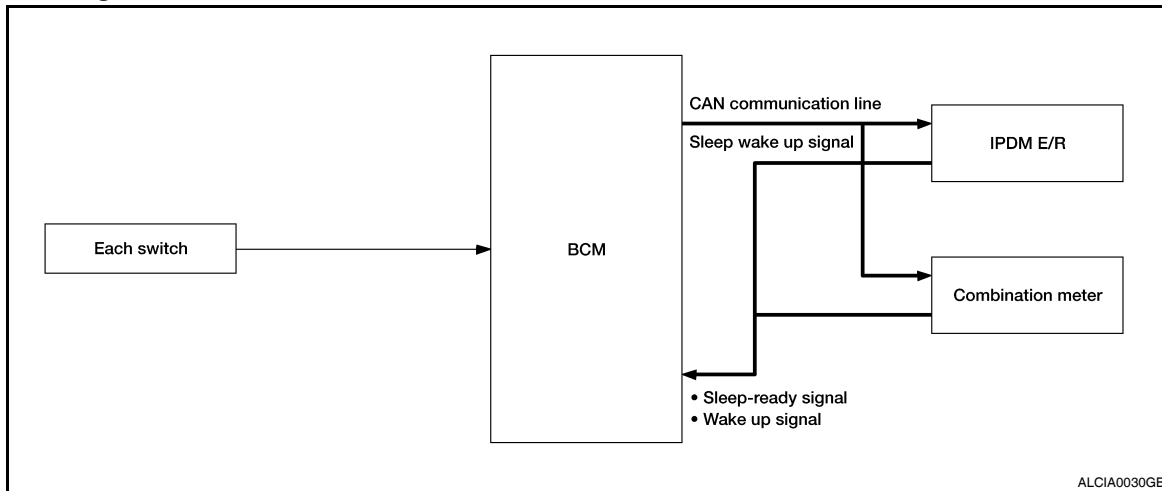

### System Description

INFOID:000000005460588

#### OUTLINE

- IPDM E/R incorporates a power consumption control function that reduces the power consumption according to the vehicle status.
- IPDM E/R changes its status (control mode) with the sleep wake up signal received from BCM via CAN communication.

#### Normal mode (wake-up)

- CAN communication is normally performed with other control units.
- Individual unit control by IPDM E/R is normally performed.

#### Low power consumption mode (sleep)

- Low power consumption control is active.
- CAN transmission is stopped.

#### SLEEP MODE ACTIVATION

- IPDM E/R judges that the sleep-ready conditions are fulfilled when the ignition switch is OFF and none of the conditions below are present. Then it transmits a sleep-ready signal (ready) to BCM via CAN communication.
  - Front wiper fail-safe operation
  - Outputting signals to actuators
  - Switches or relays operating
  - Auto active test is starting
  - Emergency OFF
  - Output requests are being received from control units via CAN communication.
- IPDM E/R stops CAN communication and enters the low power consumption mode when it receives a sleep wake up signal (sleep) from BCM and the sleep-ready conditions are fulfilled.

#### WAKE-UP OPERATION

- IPDM E/R changes from the low power consumption mode to the normal mode when it receives a sleep wake-up signal (wake up) from BCM or any of the following conditions is fulfilled. In addition, it transmits a sleep-ready signal (not-ready) to BCM via CAN communication to report the CAN communication start.
  - Ignition switch ON
  - An output request is received from a control unit via CAN communication.

# POWER CONSUMPTION CONTROL SYSTEM

< FUNCTION DIAGNOSIS >

[IPDM E/R]

## Component Parts Location

INFOID:000000005460589

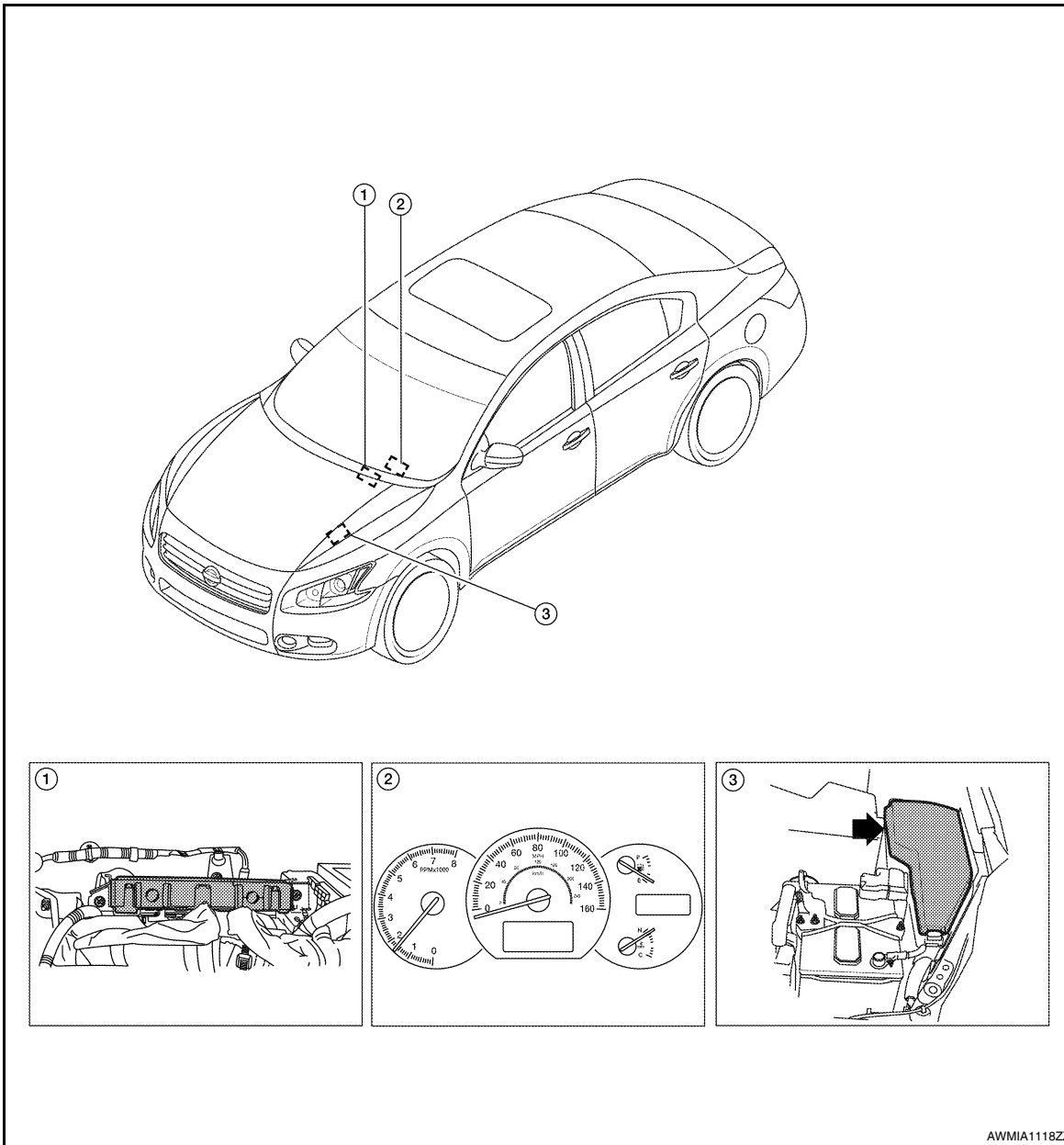

1. BCM M16, M17, M18, M19, M20, M21 (view with instrument panel removed)

2. Combination meter M24

3. IPDM E/R E16, E17, E18, E200, E201, F10

AWMIA1118Z

A  
B  
C  
D  
E  
F  
G  
H  
I  
J  
K  
L  
N  
O  
P

PCS

## DIAGNOSIS SYSTEM (IPDM E/R)

### Diagnosis Description

INFOID:000000005460590

#### AUTO ACTIVE TEST

##### Description

In auto active test mode, the IPDM E/R sends a drive signal to the following systems to check their operation.

- Oil pressure warning lamp
- Front wiper (LO, HI)
- Parking lamps
- License plate lamps
- Tail lamps
- Front fog lamps (if equipped)
- Headlamps (LO, HI)
- A/C compressor (magnet clutch)
- Cooling fans

##### Operation Procedure

1. Close the hood and lift the wiper arms from the windshield. (Prevent windshield damage due to wiper operation)  
**NOTE:**  
 When auto active test is performed with hood opened, sprinkle water on windshield beforehand.
2. Turn ignition switch OFF.
3. Turn the ignition switch ON, and within 20 seconds, press the front door switch LH 10 times. Then turn the ignition switch OFF.  
**CAUTION:**  
**Close front door RH.**
4. Turn the ignition switch ON within 10 seconds. After that the horn sounds once and the auto active test starts.
5. The oil pressure warning lamp starts blinking when the auto active test starts.
6. After a series of the following operations is repeated 3 times, auto active test is completed.

##### NOTE:

When auto active test mode has to be cancelled halfway through test, turn ignition switch OFF.

##### CAUTION:

- If auto active test mode cannot be actuated, check door switch system. Refer to [DLK-68](#), "[Component Function Check](#)".
- Do not start the engine.

##### Inspection in Auto Active Test Mode

When auto active test mode is actuated, the following 6 steps are repeated 3 times.

Operation sequence	Inspection Location	Operation
1	Oil pressure warning lamp	Blinks continuously during operation of auto active test
2	Front wiper	LO for 5 seconds → HI for 5 seconds
3	<ul style="list-style-type: none"> <li>• Parking lamps</li> <li>• License plate lamps</li> <li>• Tail lamps</li> <li>• Front fog lamps (if equipped)</li> </ul>	10 seconds
4	Headlamps	LO ↔ HI 5 times
5	A/C compressor (magnet clutch)	ON ↔ OFF 5 times
6*	Cooling fans	MID for 5 seconds → HI for 5 seconds

\*: Outputs duty ratio of 50% for 5 seconds → duty ratio of 100% for 5 seconds on the cooling fan control module.

# DIAGNOSIS SYSTEM (IPDM E/R)

< FUNCTION DIAGNOSIS >

[IPDM E/R]

Concept of auto active test

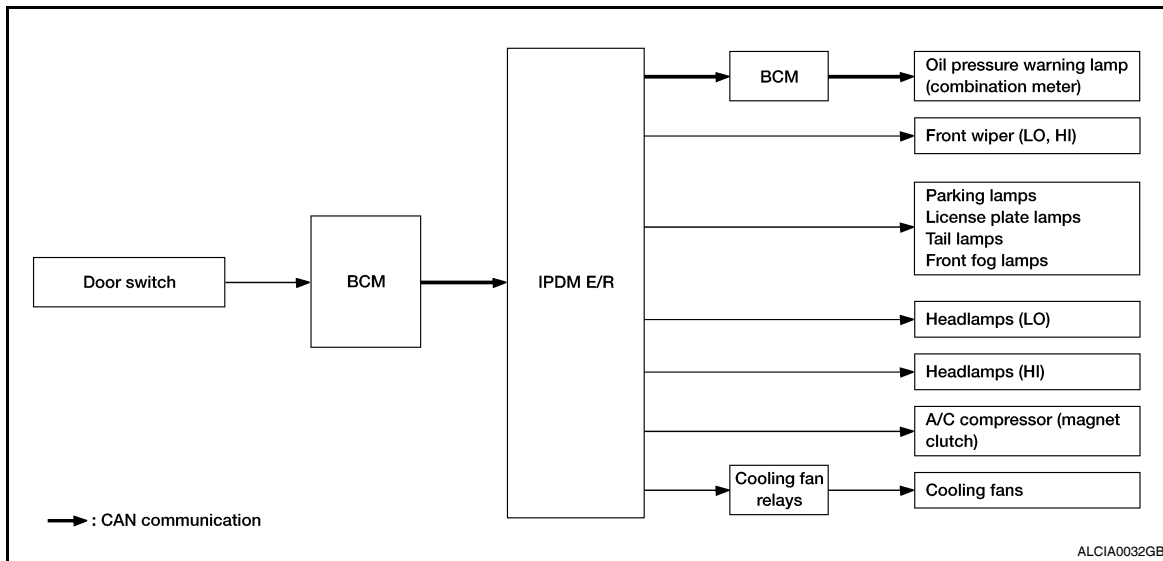

- IPDM E/R starts the auto active test with the door switch signals transmitted by BCM via CAN communication. Therefore, the CAN communication line between IPDM E/R and BCM is considered normal if the auto active test starts successfully.
- The auto active test facilitates troubleshooting if any systems controlled by IPDM E/R cannot be operated.

Diagnosis chart in auto active test mode

Symptom	Inspection contents	Possible cause
Any of the following components do not operate <ul style="list-style-type: none"> <li>• Parking lamps</li> <li>• License plate lamps</li> <li>• Tail lamps</li> <li>• Front fog lamps (if equipped)</li> <li>• Headlamp (HI, LO)</li> <li>• Front wiper</li> </ul>	Perform auto active test. Does the applicable system operate?	YES BCM signal input circuit
		NO <ul style="list-style-type: none"> <li>• Lamp or motor</li> <li>• Lamp or motor ground circuit</li> <li>• Harness or connector between IPDM E/R and applicable system</li> <li>• IPDM E/R</li> </ul>
A/C compressor does not operate	Perform auto active test. Does the magnet clutch operate?	YES <ul style="list-style-type: none"> <li>• Combination meter signal input circuit</li> <li>• CAN communication signal between combination meter and ECM</li> <li>• CAN communication signal between ECM and IPDM E/R</li> </ul>
		NO <ul style="list-style-type: none"> <li>• Magnet clutch</li> <li>• Harness or connector between IPDM E/R and magnet clutch</li> <li>• IPDM E/R</li> </ul>

# DIAGNOSIS SYSTEM (IPDM E/R)

< FUNCTION DIAGNOSIS >

[IPDM E/R]

Symptom	Inspection contents	Possible cause
Oil pressure warning lamp does not operate	Perform auto active test. Does the oil pressure warning lamp blink?	YES <ul style="list-style-type: none"> <li>• Harness or connector between IPDM E/R and oil pressure switch</li> <li>• Oil pressure switch</li> <li>• IPDM E/R</li> </ul>
		NO <ul style="list-style-type: none"> <li>• CAN communication signal between IPDM E/R and BCM</li> <li>• CAN communication signal between BCM and combination meter</li> <li>• Combination meter</li> </ul>
Cooling fan does not operate	Perform auto active test. Does the cooling fan operate?	YES <ul style="list-style-type: none"> <li>• ECM signal input circuit</li> <li>• CAN communication signal between ECM and IPDM E/R</li> </ul>
		NO <ul style="list-style-type: none"> <li>• Cooling fan</li> <li>• Harness or connector between cooling fan and cooling fan relays</li> <li>• Cooling fan relays</li> <li>• Harness or connector between IPDM E/R and cooling fan relays</li> <li>• IPDM E/R</li> </ul>

## CONSULT - III Function (IPDM E/R)

INFOID:000000005460591

### APPLICATION ITEM

CONSULT-III performs the following functions via CAN communication with IPDM E/R.

Diagnosis mode	Description
ECU Identification	Allows confirmation of IPDM E/R part number.
Self Diagnostic Result	Displays the diagnosis results judged by IPDM E/R.
Data Monitor	Displays the real-time input/output data from IPDM E/R input/output data.
Active Test	IPDM E/R can provide a drive signal to electronic components to check their operations.
CAN Diag Support Monitor	The results of transmit/receive diagnosis of CAN communication can be read.

### SELF DIAGNOSTIC

Refer to [PCS-38. "DTC Index"](#).

### DATA MONITOR

Monitor item

Monitor Item [Unit]	MAIN SIGNALS	Description
MOTOR FAN REQ [1,2,3,4]	×	Displays the value of the cooling fan speed signal received from ECM via CAN communication.
AC COMP REQ [Off/On]	×	Displays the status of the A/C compressor request signal received from ECM via CAN communication.
TAIL&CLR REQ [Off/On]	×	Displays the status of the position light request signal received from BCM via CAN communication.
HL LO REQ [Off/On]	×	Displays the status of the low beam request signal received from BCM via CAN communication.
HL HI REQ [Off/On]	×	Displays the status of the high beam request signal received from BCM via CAN communication.



# DIAGNOSIS SYSTEM (IPDM E/R)

< FUNCTION DIAGNOSIS >

[IPDM E/R]

Monitor Item [Unit]	MAIN SIG- NALS	Description
FR FOG REQ [Off/On]	×	Displays the status of the front fog light request signal received from BCM via CAN communication.
FR WIP REQ [Stop/1LOW/Low/Hi]	×	Displays the status of the front wiper request signal received from BCM via CAN communication.
WIP AUTO STOP [STOP P/ACT P]	×	Displays the status of the front wiper auto stop signal judged by IPDM E/R.
WIP PROT [Off/BLOCK]	×	Displays the status of the front wiper fail-safe operation judged by IPDM E/R.
IGN RLY1 -REQ [Off/On]		Displays the status of the ignition switch ON signal received from BCM via CAN communication.
IGN RLY [Off/On]	×	Displays the status of the ignition relay judged by IPDM E/R.
PUSH SW [Off/On]		Displays the status of the push-button ignition switch judged by IPDM E/R.
INTER/NP SW [Off/On]		Displays the status of the CVT shift position judged by IPDM E/R.
ST RLY CONT [Off/On]		Displays the status of the starter relay status signal received from BCM via CAN communication.
IHBT RLY -REQ [Off/On]		Displays the status of the starter control relay signal received from BCM via CAN communication.
ST/INHI RLY [Off/ ST /INHI]		Displays the status of the starter relay and starter control relay judged by IPDM E/R.
DETENT SW [Off/On]		Displays the status of the CVT shift selector (detention switch) judged by IPDM E/R.
S/L RLY -REQ <sup>1</sup> [Off/On]		Displays the status of the steering lock relay request received from BCM via CAN communication.
S/L STATE <sup>1</sup> [LOCK/UNLK/UNKWN]		Displays the status of the electronic steering column lock judged by IPDM E/R.
DTRL REQ [Off]		Displays the status of the daytime light request signal received from BCM via CAN communication.
OIL P SW [Open/Close]		Displays the status of the oil pressure switch judged by IPDM E/R.
THFT HRN REQ [Off/On]		Displays the status of the theft warning horn request signal received from BCM via CAN communication.
HORN CHIRP [Off/On]		Displays the status of the horn reminder signal received from BCM via CAN communication.

1: Early production

## ACTIVE TEST

Test item

Test item	Operation	Description
HORN	On	Operates horn relay 1 and horn relay 2 for 20 ms.
	Off	OFF
FRONT WIPER	Lo	Operates the front wiper relay.
	Hi	Operates the front wiper relay and front wiper high relay.
MOTOR FAN	1	OFF
	2	Outputs 50% pulse duty signal (PWM signal) to the cooling fan control module.
	3	Outputs 80% pulse duty signal (PWM signal) to the cooling fan control module.
	4	Outputs 100% pulse duty signal (PWM signal) to the cooling fan control module.

# DIAGNOSIS SYSTEM (IPDM E/R)

[IPDM E/R]

## < FUNCTION DIAGNOSIS >

Test item	Operation	Description
EXTERNAL LAMPS	Off	OFF
	TAIL	Operates the tail lamp relay.
	Lo	Operates the headlamp low relay.
	Hi	Operates the headlamp low relay and ON/OFF the headlamp high relay at 1 second intervals.
	Fog	Operates the front fog lamp relay.

# U1000 CAN COMM CIRCUIT

< COMPONENT DIAGNOSIS >

[IPDM E/R]

## COMPONENT DIAGNOSIS

### U1000 CAN COMM CIRCUIT

#### Description

INFOID:000000005460592

Refer to [LAN-25, "CAN Communication Signal Chart"](#).

#### DTC Logic

INFOID:000000005460593

#### DTC DETECTION LOGIC

DTC	CONSULT-III display description	DTC Detection Condition	Possible cause
U1000	CAN COMM CIRCUIT	When IPDM E/R cannot communicate CAN communication signal continuously for 2 seconds or more	In CAN communication system, any item (or items) of the following listed below is malfunctioning. <ul style="list-style-type: none"><li>• Transmission</li><li>• Receiving (ECM)</li><li>• Receiving (BCM)</li><li>• Receiving (Combination meter)</li></ul>

#### DTC CONFIRMATION PROCEDURE

#### Diagnosis Procedure

INFOID:000000005460594

#### 1. PERFORM SELF DIAGNOSTIC

1. Turn ignition switch ON and wait for 2 seconds or more.
2. Check "Self Diagnostic Result" of IPDM E/R.

Is "CAN COMM CIRCUIT" displayed?

- YES >> Refer to [PCS-19, "DTC Logic"](#).  
NO >> Refer to [GI-39, "Intermittent Incident"](#).

A  
B  
C  
D  
E  
F  
G  
H  
I  
J  
K  
L  
N  
O  
P

PCS

# B2098 IGNITION RELAY ON STUCK

< COMPONENT DIAGNOSIS >

[IPDM E/R]

## B2098 IGNITION RELAY ON STUCK

### Description

INFOID:000000005460595

- IPDM E/R operates the ignition relay when it receives an ignition switch ON signal from BCM via CAN communication.
- Turn the ignition relay OFF by pressing the push-button ignition switch once when the vehicle speed is 4 km/h (2.5 MPH) or less.
- Turn the ignition relay OFF with the following operation when the vehicle speed is more than 4 km/h (2.5 MPH) or when an abnormal condition occurs in CAN communication from the unified meter (Emergency OFF)
  - Press and hold the push-button ignition switch for 2 seconds or more.
  - Press the push-button ignition switch 3 times within 1.5 seconds.

#### NOTE:

The ignition relay does not turn ON for 3 seconds after emergency OFF even if the push-button ignition switch is pressed.

### DTC Logic

INFOID:000000005460596

#### DTC DETECTION LOGIC

DTC	CONSULT-III display description	DTC Detection Condition	Possible causes
B2098	IGN RELAY ON	The ignition relay ON is detected for 1 second at ignition switch OFF (CPU monitors the status at the contact and excitation coil circuits of the ignition relay inside it)	Ignition relay malfunction

### Diagnosis Procedure

INFOID:000000005460597

#### 1. PERFORM SELF DIAGNOSIS

1. Turn the ignition switch ON.
2. Erase "Self Diagnostic Result" of IPDM E/R.
3. Turn ignition switch OFF, and wait for 1 second or more.
4. Turn the ignition switch ON. Check "Self Diagnostic Result" again.

#### Is "IGN RELAY ON" displayed?

- YES >> Replace IPDM E/R. Refer to [PCS-41, "Removal and Installation"](#).  
NO >> Refer to [GI-39, "Intermittent Incident"](#).

# B2099 IGNITION RELAY OFF STUCK

< COMPONENT DIAGNOSIS >

[IPDM E/R]

## B2099 IGNITION RELAY OFF STUCK

### Description

INFOID:000000005460598

- IPDM E/R operates the ignition relay when it receives an ignition switch ON signal from BCM via CAN communication.
- Turn the ignition relay OFF by pressing the push-button ignition switch once when the vehicle speed is 4 km/h (2.5 MPH) or less.
- Turn the ignition relay OFF with the following operation when the vehicle speed is more than 4 km/h (2.5 MPH) or when an abnormal condition occurs in CAN communication from the unified meter (Emergency OFF)
  - Press and hold the push-button ignition switch for 2 seconds or more.
  - Press the push-button ignition switch 3 times within 1.5 seconds.

#### NOTE:

The ignition relay does not turn ON for 3 seconds after emergency OFF even if the push-button ignition switch is pressed.

### DTC Logic

INFOID:000000005460599

#### DTC DETECTION LOGIC

DTC	CONSULT-III display description	DTC Detection Condition	Possible causes
B2099	IGN RELAY OFF	The ignition relay OFF is detected for 1 second at ignition switch ON (CPU monitors the status at the contact and excitation coil circuits of the ignition relay inside it)	Ignition relay malfunction

### Diagnosis Procedure

INFOID:000000005460600

#### 1. PERFORM SELF DIAGNOSIS

1. Turn the ignition switch ON.
2. Erase "Self Diagnostic Result".
3. Turn ignition switch OFF.
4. Turn the ignition switch ON. Check "Self Diagnostic Result" again.

#### Is "IGN RELAY OFF" displayed?

- YES >> Replace IPDM E/R. Refer to [PCS-41, "Removal and Installation"](#).  
NO >> Refer to [GI-39, "Intermittent Incident"](#).

A  
B  
C  
D  
E  
F  
G  
H  
I  
J  
K  
L  
N  
O  
P

PCS

# POWER SUPPLY AND GROUND CIRCUIT

< COMPONENT DIAGNOSIS >

[IPDM E/R]

## POWER SUPPLY AND GROUND CIRCUIT

### Diagnosis Procedure

INFOID:000000005460601

Regarding Wiring Diagram information, refer to [PCS-31, "Wiring Diagram"](#).

### 1. CHECK FUSES AND FUSIBLE LINK

Check that the following IPDM E/R fuses or fusible link are not blown.

Terminal No.	Signal name	Fuses and fusible link No.
1, 2	Battery power supply	B, D
—		42
—		43

Is the fuse blown?

- YES >> Replace the blown fuse or fusible link after repairing the affected circuit.  
 NO >> GO TO 2

### 2. CHECK POWER SUPPLY CIRCUIT

- Turn ignition switch OFF.
- Disconnect IPDM E/R connectors.
- Check voltage between IPDM E/R harness connector and ground.

Terminals		Voltage (V) (Approx.)
(+)	(-)	
IPDM E/R		Battery voltage
Connector	Terminal	
E16	1 2	

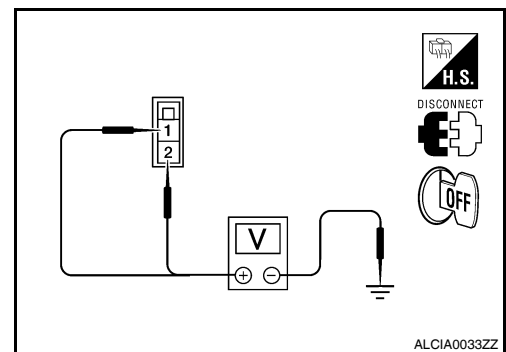

Is the measurement value normal?

- YES >> GO TO 3  
 NO >> Repair harness or connector.

### 3. CHECK GROUND CIRCUIT

Check continuity between IPDM E/R harness connectors and ground.

IPDM E/R		Ground	Continuity
Connector	Terminal		
A: E18	12	Ground	Yes
B: E17	41		

Does continuity exist?

- YES >> Inspection End.  
 NO >> Repair harness or connector.

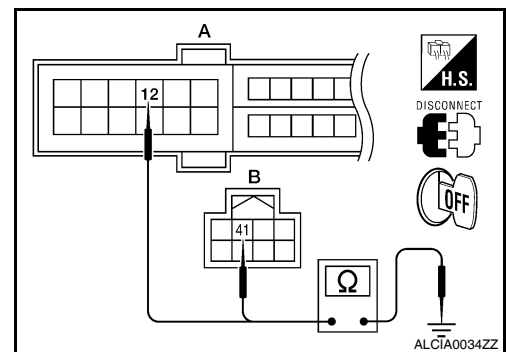

# IPDM E/R (INTELLIGENT POWER DISTRIBUTION MODULE ENGINE ROOM)

< ECU DIAGNOSIS >

[IPDM E/R]

## ECU DIAGNOSIS

### IPDM E/R (INTELLIGENT POWER DISTRIBUTION MODULE ENGINE ROOM)

Reference Value

INFOID:000000005460602

#### VALUES ON THE DIAGNOSIS TOOL

Monitor Item	Condition		Value/Status
MOTOR FAN REQ	Engine idle speed	Changes depending on engine coolant temperature, air conditioner operation status, vehicle speed, etc.	1,2,3,4
AC COMP REQ	Engine running	A/C switch OFF	Off
		A/C switch ON (Compressor is operating)	On
TAIL&CLR REQ	Lighting switch OFF		Off
	Lighting switch 1ST, 2ND, HI or AUTO (Light is illuminated)		On
HL LO REQ	Lighting switch OFF		Off
	Lighting switch 2ND HI or AUTO (Light is illuminated)		On
HL HI REQ	Lighting switch OFF		Off
	Lighting switch HI		On
FR FOG REQ	Lighting switch 2ND or AUTO (Light is illuminated)	Front fog lamp switch OFF	Off
		<ul style="list-style-type: none"> <li>• Front fog lamp switch ON</li> <li>• Daytime running light activated (Only for Canada models)</li> </ul>	On
FR WIP REQ	Ignition switch ON	Front wiper switch OFF	STOP
		Front wiper switch INT	1LOW
		Front wiper switch LO	Low
		Front wiper switch HI	Hi
WIP AUTO STOP	Ignition switch ON	Front wiper stop position	STOP P
		Any position other than front wiper stop position	ACT P
WIP PROT	Ignition switch ON	Front wiper operates normally	Off
		Front wiper stops at fail-safe operation	BLOCK
IGN RLY1 -REQ	Ignition switch OFF or ACC		Off
	Ignition switch ON		On
IGN RLY	Ignition switch OFF or ACC		Off
	Ignition switch ON		On
PUSH SW	Release the push-button ignition switch		Off
	Press the push-button ignition switch		On
INTER/NP SW	Ignition switch ON	CVT selector lever in any position other than P or N	Off
	Ignition switch ON	CVT selector lever in P or N position	On
ST RLY CONT	Ignition switch ON		Off
	At engine cranking		On

A  
B  
C  
D  
E  
F  
G  
H  
I  
J  
K  
L

PCS

N  
O  
P

# IPDM E/R (INTELLIGENT POWER DISTRIBUTION MODULE ENGINE ROOM)

< ECU DIAGNOSIS >

[IPDM E/R]

Monitor Item	Condition	Value/Status
IHBT RLY -REQ	Ignition switch ON	Off
	At engine cranking	On
ST/INHI RLY	Ignition switch ON	Off
	At engine cranking	ST →INHI
	The status of starter relay or starter control relay cannot be recognized by the battery voltage malfunction, etc. when the starter relay is ON and the starter control relay is OFF	UNKWN
DETENT SW	Ignition switch ON <ul style="list-style-type: none"> <li>• Press the selector button with CVT selector lever in P position</li> <li>• CVT selector lever in any position other than P</li> </ul>	Off
	Release the CVT selector button with CVT selector lever in P position	On
S/L RLY -REQ <sup>1</sup>	None of the conditions below are present	Off
	<ul style="list-style-type: none"> <li>• Open the driver door after the ignition switch is turned OFF (for a few seconds)</li> <li>• Press the push-button ignition switch when the steering lock is activated</li> </ul>	On
S/L STATE <sup>1</sup>	Steering lock is activated	LOCK
	Steering lock is deactivated	UNLK
	[DTC B210A] is detected	UNKWN
DTRL -REQ	DTRL ON	On
	DTRL OFF	Off
OIL P SW	Ignition switch OFF, ACC or engine running	Open
	Ignition switch ON	Close
THFT HRN REQ	Not operated	Off
	<ul style="list-style-type: none"> <li>• Panic alarm is activated</li> <li>• Horn is activated with VEHICLE SECURITY (THEFT WARNING) SYSTEM</li> </ul>	On
HORN CHIRP	Not operated	Off
	Door locking with Intelligent Key (horn chirp mode)	On

1: Early production



# IPDM E/R (INTELLIGENT POWER DISTRIBUTION MODULE ENGINE ROOM)

< ECU DIAGNOSIS >

[IPDM E/R]

## TERMINAL LAYOUT

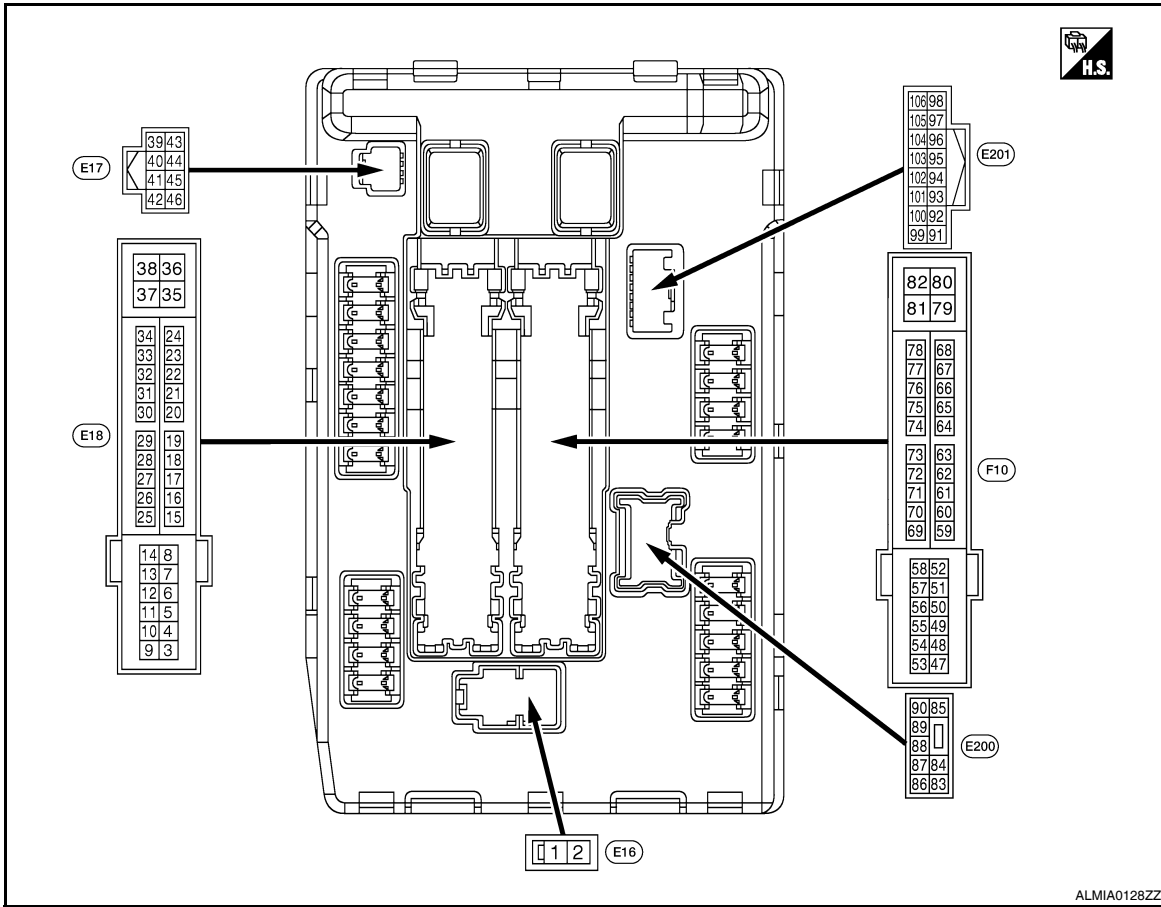

## PHYSICAL VALUES

Terminal No. (Wire color)		Description		Condition		Value (Approx.)
+	-	Signal name	Input/ Output			
1 (R)	Ground	Battery power supply	Input	Ignition switch OFF		Battery voltage
2 (L)	Ground	Battery power supply	Input	Ignition switch OFF		Battery voltage
4 (LG)	Ground	Front wiper LO	Output	Ignition switch OFF	Front wiper switch OFF	0 V
				Ignition switch ON	Front wiper switch LO	Battery voltage
5 (Y)	Ground	Front wiper HI	Output	Ignition switch OFF	Front wiper switch OFF	0 V
				Ignition switch ON	Front wiper switch HI	Battery voltage
6 (L)	Ground	Daytime light relay power supply (Canada models only)	Output	Ignition switch OFF		Battery voltage
7 (GR)	Ground	Tail, license plate lamps & interior lamps	Output	Ignition switch OFF	Lighting switch OFF	0 V
				Ignition switch ON	Lighting switch 1ST	Battery voltage
10 (BR)	Ground	ECM relay power supply	Output	Ignition switch OFF (For a few seconds after turning ignition switch OFF)		0 V
				<ul style="list-style-type: none"> <li>Ignition switch ON</li> <li>Ignition switch OFF (More than a few seconds after turning ignition switch OFF)</li> </ul>		Battery voltage

# IPDM E/R (INTELLIGENT POWER DISTRIBUTION MODULE ENGINE ROOM)

< ECU DIAGNOSIS >

[IPDM E/R]

Terminal No. (Wire color)		Description		Condition		Value (Approx.)
+	-	Signal name	Input/ Output			
11 <sup>1</sup> (O)	Ground	Electronic steering column lock power supply	Output	Ignition switch OFF	A few seconds after opening the driver door	Battery voltage
				Ignition switch LOCK	Press the push-button ignition switch	Battery voltage
				Ignition switch ACC or ON		0 V
12 (B)	Ground	Ground	—	Ignition switch ON		0 V
13 (SB)	Ground	Fuel pump power supply	Output	Approximately 1 second or more after turning the ignition switch ON		0 V
				<ul style="list-style-type: none"> <li>• Approximately 1 second after turning the ignition switch ON</li> <li>• Engine running</li> </ul>		Battery voltage
15 (W)	Ground	Ignition relay-1 power supply	Output	Ignition switch OFF		0 V
				Ignition switch ON		Battery voltage
16 (R)	Ground	Front wiper auto stop	Input	Ignition switch ON	Front wiper stop position	0 V
					Any position other than front wiper stop position	Battery voltage
19 (Y)	Ground	Ignition relay-1 power supply	Output	Ignition switch OFF		0 V
				Ignition switch ON		Battery voltage
20 (L)	Ground	Ambient sensor ground	—	Ignition switch ON		0V
21 (LG)	Ground	Ambient sensor	—	Ignition switch ON		5V
22 (SB)	Ground	Refrigerant pressure sensor ground	—	Ignition switch ON		0V
23 (GR)	Ground	Refrigerant pressure sensor	—	<ul style="list-style-type: none"> <li>• Ignition switch ON (READY)</li> <li>• Both A/C switch and blower motor switch ON (electric compressor operates)</li> </ul>		1.0 - 4.0V
24 (G)	Ground	Refrigerant pressure sensor power supply	—	Ignition switch ON		5V
25 (GR)	Ground	Ignition relay-1 power supply	Output	Ignition switch OFF		0 V
				Ignition switch ON		Battery voltage
27 (W)	Ground	Ignition relay monitor	Input	Ignition switch OFF or ACC		Battery voltage
				Ignition switch ON		0 V
28 (SB)	Ground	Push-button ignition switch	Input	Press the push-button ignition switch		0 V
				Release the push-button ignition switch		Battery voltage
30 (BR)	Ground	Starter relay control	Input	CVT selector lever in any position other than P or N (ignition switch ON)		0 V
				CVT selector lever P or N (ignition switch ON)		Battery voltage
32 <sup>1</sup> (P)	Ground	Electronic steering column lock unit condition-1	Input	Electronic steering column lock is activated		0 V
				Electronic steering column lock is deactivated		Battery voltage

# IPDM E/R (INTELLIGENT POWER DISTRIBUTION MODULE ENGINE ROOM)

< ECU DIAGNOSIS >

[IPDM E/R]

Terminal No. (Wire color)		Description		Condition		Value (Approx.)	
33 <sup>1</sup> (G)	Ground	Electronic steering column lock condition-2	Input	Electronic steering column lock is activated		Battery voltage	A
				Electronic steering column lock is deactivated		0 V	B
34 (O)	Ground	Cooling fan relay-3 control	Input	Ignition switch OFF or ACC		0 V	C
				Ignition switch ON		0.7 V	
35 (P)	Ground	Cooling fan motor control	Output	Ignition switch OFF or ACC		0 V	D
				Ignition switch ON		0.7 V	
36 (G)	Ground	Battery power supply	Input	Ignition switch OFF		Battery voltage	E
38 (GR)	Ground	Cooling fan motor control	Output	Ignition switch OFF or ACC		0 V	
				Ignition switch ON		0.7 V	
39 (P)	—	CAN - L	Input/ Output	—		—	F
40 (L)	—	CAN - H	Input/ Output	—		—	G
41 (B)	Ground	Ground	—	Ignition switch ON		0 V	
42 (SB)	Ground	Cooling fan relay-2 control	Input	Ignition switch OFF or ACC		0 V	H
				Ignition switch ON		0.7 V	
43 (Y)	Ground	CVT shift selector (Detention switch)	Input	Ignition switch ON	Press the CVT selector button (CVT selector lever P)	Battery voltage	I
					<ul style="list-style-type: none"> <li>• CVT selector lever in any position other than P</li> <li>• Release the CVT selector button (CVT selector lever P)</li> </ul>	0 V	J
44 (W)	Ground	Horn relay control	Input	The horn is deactivated		Battery voltage	
				The horn is activated		0 V	L
45 (GR)	Ground	Anti theft horn relay control	Input	The horn is deactivated		Battery voltage	
				The horn is activated		0 V	
46 (BR)	Ground	Starter relay control	Input	CVT selector lever in any position other than P or N (ignition switch ON)		0 V	PCS
				CVT selector lever P or N (ignition switch ON)		Battery voltage	N
48 (W)	Ground	A/C relay power supply	Output	Engine running	A/C switch OFF	0 V	
					A/C switch ON (A/C compressor is operating)	Battery voltage	O
49 (R/G)	Ground	ECM relay power supply	Output	Ignition switch OFF (For a few seconds after turning ignition switch OFF)		0 V	P
				<ul style="list-style-type: none"> <li>• Ignition switch ON</li> <li>• Ignition switch OFF (More than a few seconds after turning ignition switch OFF)</li> </ul>		Battery voltage	
51 (LG)	Ground	Ignition relay power supply	Output	Ignition switch OFF		0 V	
				Ignition switch ON		Battery voltage	

# IPDM E/R (INTELLIGENT POWER DISTRIBUTION MODULE ENGINE ROOM)

< ECU DIAGNOSIS >

[IPDM E/R]

Terminal No. (Wire color)		Description		Condition		Value (Approx.)
+	-	Signal name	Input/ Output			
52 (Y/G)	Ground	Ignition relay power supply	Output	Ignition switch OFF		0 V
				Ignition switch ON		Battery voltage
53 (R/W)	Ground	ECM relay power supply	Output	Ignition switch OFF (For a few seconds after turning ignition switch OFF)		0 V
				<ul style="list-style-type: none"> <li>• Ignition switch ON</li> <li>• Ignition switch OFF (More than a few seconds after turning ignition switch OFF)</li> </ul>		Battery voltage
54 (G/W)	Ground	Throttle control motor relay power supply	Output	Ignition switch OFF (For a few seconds after turning ignition switch OFF)		0 V
				<ul style="list-style-type: none"> <li>• Ignition switch ON</li> <li>• Ignition switch OFF (More than a few seconds after turning ignition switch OFF)</li> </ul>		Battery voltage
55 (W/L)	Ground	ECM power supply	Output	Ignition switch OFF		Battery voltage
56 (R/Y)	Ground	Ignition relay power supply	Output	Ignition switch OFF		0 V
				Ignition switch ON		Battery voltage
57 (O)	Ground	Ignition relay power supply	Output	Ignition switch OFF		0 V
				Ignition switch ON		Battery voltage
58 (Y)	Ground	Ignition relay power supply	Output	Ignition switch OFF		0 V
				Ignition switch ON		Battery voltage
69 (W/B)	Ground	ECM relay control	Output	Ignition switch OFF (For a few seconds after turning ignition switch OFF)		Battery voltage
				<ul style="list-style-type: none"> <li>• Ignition switch ON</li> <li>• Ignition switch OFF (More than a few seconds after turning ignition switch OFF)</li> </ul>		0 - 1.5 V
70 (O)	Ground	Throttle control motor relay control	Output	Ignition switch ON → OFF		0 -1.0 V ↓ Battery voltage ↓ 0 V
				Ignition switch ON		0 - 1.0 V
72 (R/B)	Ground	Transmission range switch signal	Input	Ignition switch ON	CVT selector lever in P or N position	Battery voltage
					CVT selector lever in any position other than P or N position	0 V
75 (LG)	Ground	Oil pressure switch	Input	Ignition switch ON	Engine stopped	0 V
					Engine running	Battery voltage

# IPDM E/R (INTELLIGENT POWER DISTRIBUTION MODULE ENGINE ROOM)

< ECU DIAGNOSIS >

[IPDM E/R]

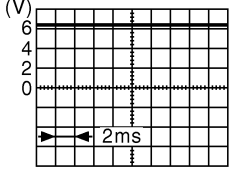
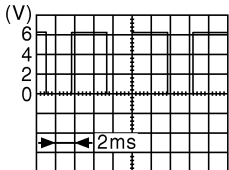
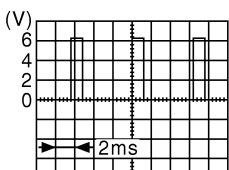
Terminal No. (Wire color)		Description		Condition		Value (Approx.)
+	-					
76 (SB)	Ground	Power generation command signal	Output	Ignition switch ON		 <p style="text-align: center;">6.3 V</p>
				40% is set on "Active test", "ALTERNATOR DUTY" of "ENGINE"		 <p style="text-align: center;">3.8 V</p>
				80% is set on "Active test", "ALTERNATOR DUTY" of "ENGINE"		 <p style="text-align: center;">1.4 V</p>
77 (GR)	Ground	Fuel pump relay control	Output	<ul style="list-style-type: none"> <li>• Approximately 1 second after turning the ignition switch ON</li> <li>• Engine running</li> </ul>		0 - 1.0 V
				Approximately 1 second or more after turning the ignition switch ON		Battery voltage
80 (B/W)	Ground	Starter motor	Output	At engine cranking		Battery voltage
83 (R/Y)	Ground	Headlamp LO (RH)	Output	Ignition switch ON	Lighting switch OFF	0 V
					Lighting switch 2ND	Battery voltage
84 (L)	Ground	Headlamp LO (LH)	Output	Ignition switch ON	Lighting switch OFF	0 V
					Lighting switch 2ND	Battery voltage
86 (W/R)	Ground	Front fog lamp (RH)	Output	Lighting switch 2ND	<ul style="list-style-type: none"> <li>• Front fog lamp switch ON</li> <li>• Daytime running light activated (Only for Canada models)</li> </ul>	Battery voltage
					Front fog lamp switch OFF	0 V
87 (L/Y)	Ground	Front fog lamp (LH)	Output	Lighting switch 2ND	<ul style="list-style-type: none"> <li>• Front fog lamp switch ON</li> <li>• Daytime running light activated (Only for Canada models)</li> </ul>	Battery voltage
					Front fog lamp switch OFF	0 V
88 (R/W)	Ground	Washer pump power supply	Output	Ignition switch ON		Battery voltage

A  
B  
C  
D  
E  
F  
G  
H  
I  
J  
K  
L

PCS

N  
O  
P

# IPDM E/R (INTELLIGENT POWER DISTRIBUTION MODULE ENGINE ROOM)

< ECU DIAGNOSIS >

[IPDM E/R]

Terminal No. (Wire color)		Description		Condition		Value (Approx.)
+	-	Signal name	Input/ Output			
89 (L/W)	Ground	Headlamp HI (RH)	Output	Ignition switch ON	• Lighting switch HI • Lighting switch PASS	Battery voltage
					Lighting switch OFF	0 V
90 (G)	Ground	Headlamp HI (LH)	Output	Ignition switch ON	• Lighting switch HI • Lighting switch PASS	Battery voltage
					Lighting switch OFF	0 V
91 (LG/ R)	Ground	Parking lamp (RH)	Output	Ignition switch ON	Lighting switch 1ST	Battery voltage
					Lighting switch OFF	0 V
92 (LG/ B)	Ground	Parking lamp (LH)	Output	Ignition switch ON	Lighting switch 1ST	Battery voltage
					Lighting switch OFF	0 V
99 (BR/ W)	Ground	Ambient sensor ground	—	Ignition switch ON		0V
100 (SB)	Ground	Ambient sensor	—	Ignition switch ON		5V
101 (W)	Ground	Refrigerant pressure sensor ground	—	Ignition switch ON		0V
102 (R)	Ground	Refrigerant pressure sensor	—	• Ignition switch ON (READY) • Both A/C switch and blower motor switch ON (electric compressor operates)		1.0 - 4.0V
103 (P)	Ground	Refrigerant pressure sensor power supply	—	Ignition switch ON		5V
105 (V)	Ground	Daytime light relay control (Only for Canada models)	Output	Ignition switch ON	Daytime light system active	Battery voltage
				Ignition switch ON	Daytime light system inactive	0 V

1: Early production

# IPDM E/R (INTELLIGENT POWER DISTRIBUTION MODULE ENGINE ROOM)

< ECU DIAGNOSIS >

[IPDM E/R]

## Wiring Diagram

INFOID:000000005460603

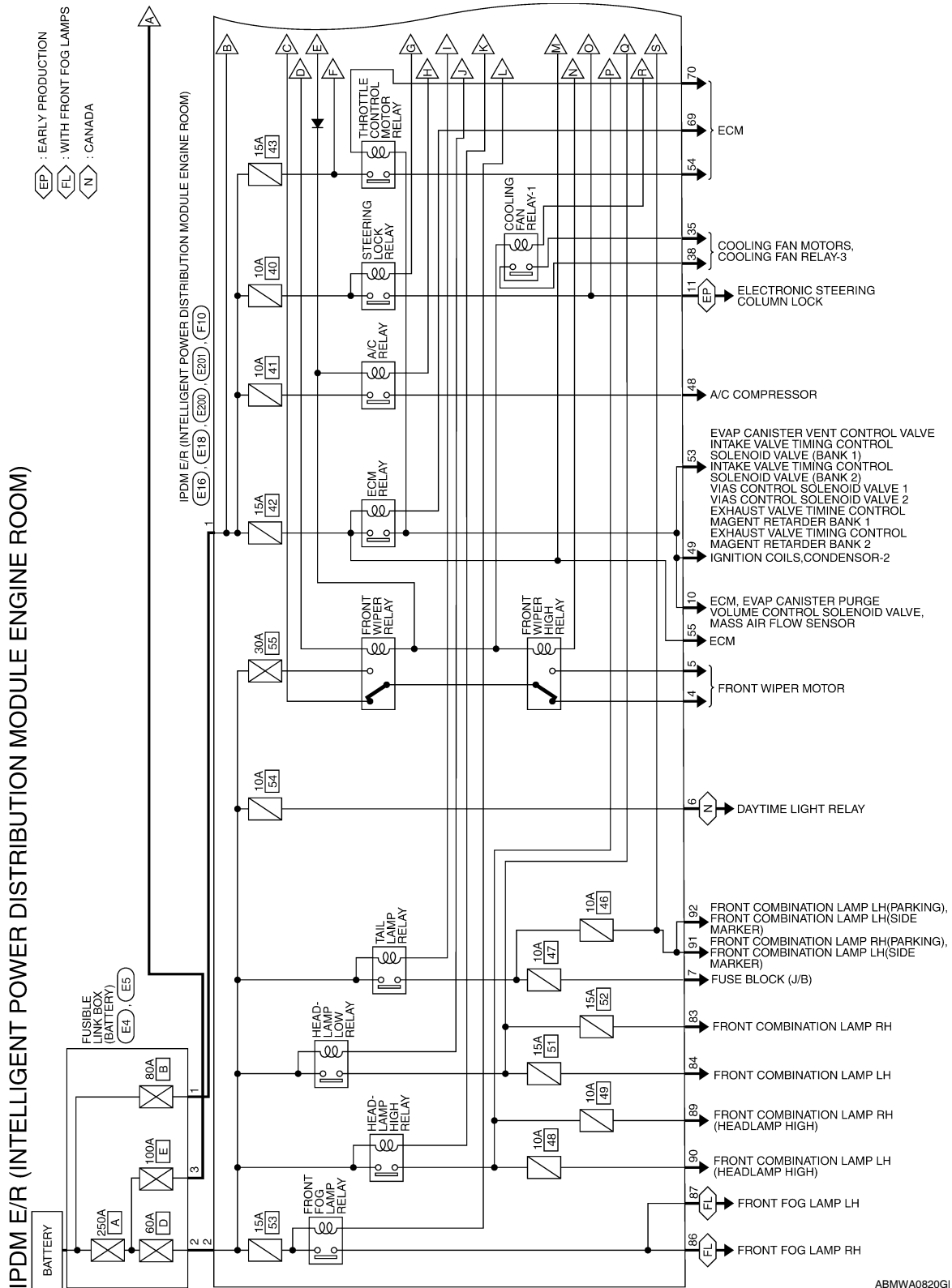

ABMWA0820GI

A  
B  
C  
D  
E  
F  
G  
H  
I  
J  
K  
L  
N  
O  
P

PCS

# IPDM E/R (INTELLIGENT POWER DISTRIBUTION MODULE ENGINE ROOM)

< ECU DIAGNOSIS >

[IPDM E/R]

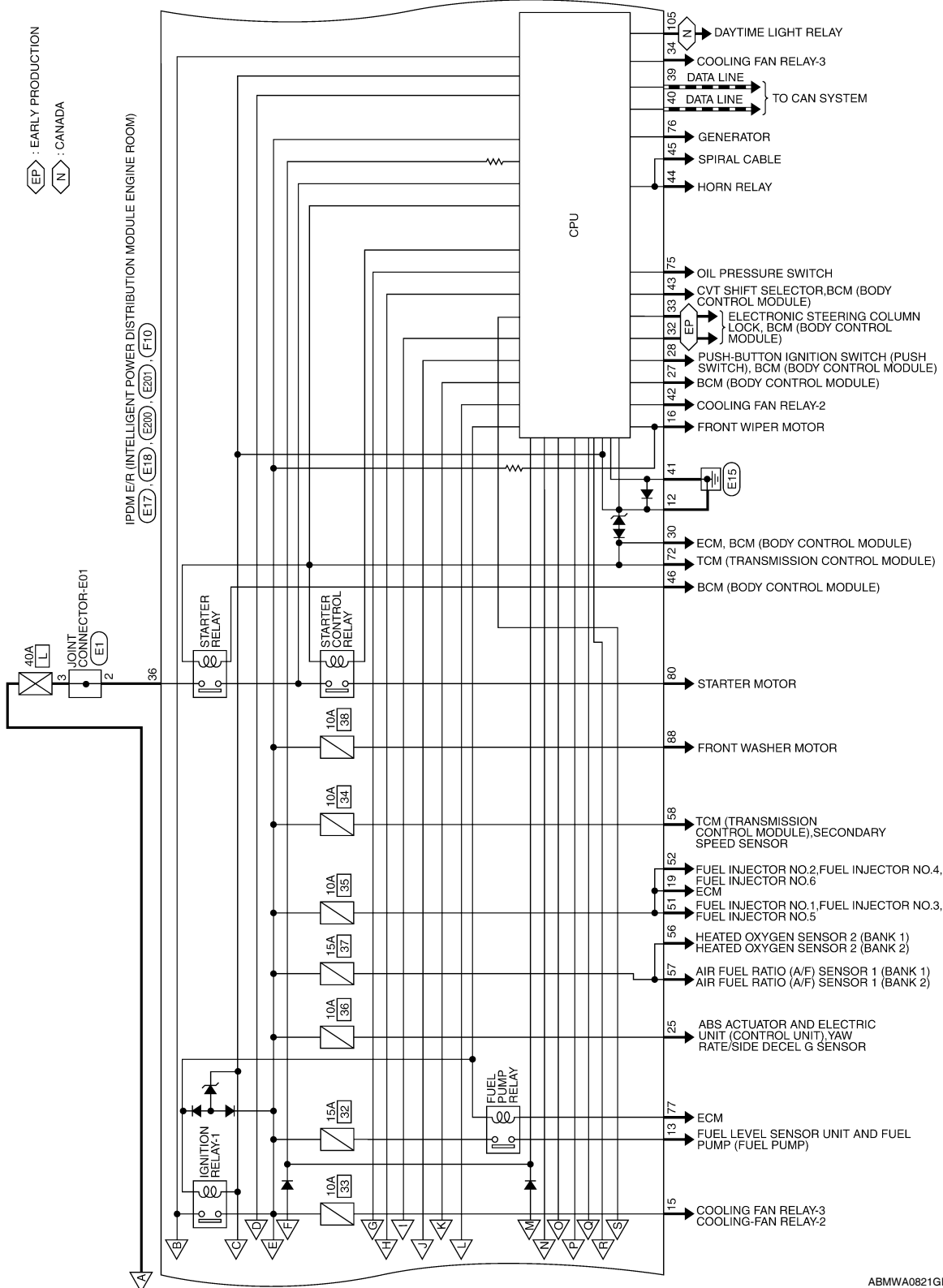

ABMWA0821GI



A  
B  
C  
D  
E  
F  
G  
H  
I  
J  
K  
L  
N  
O  
P

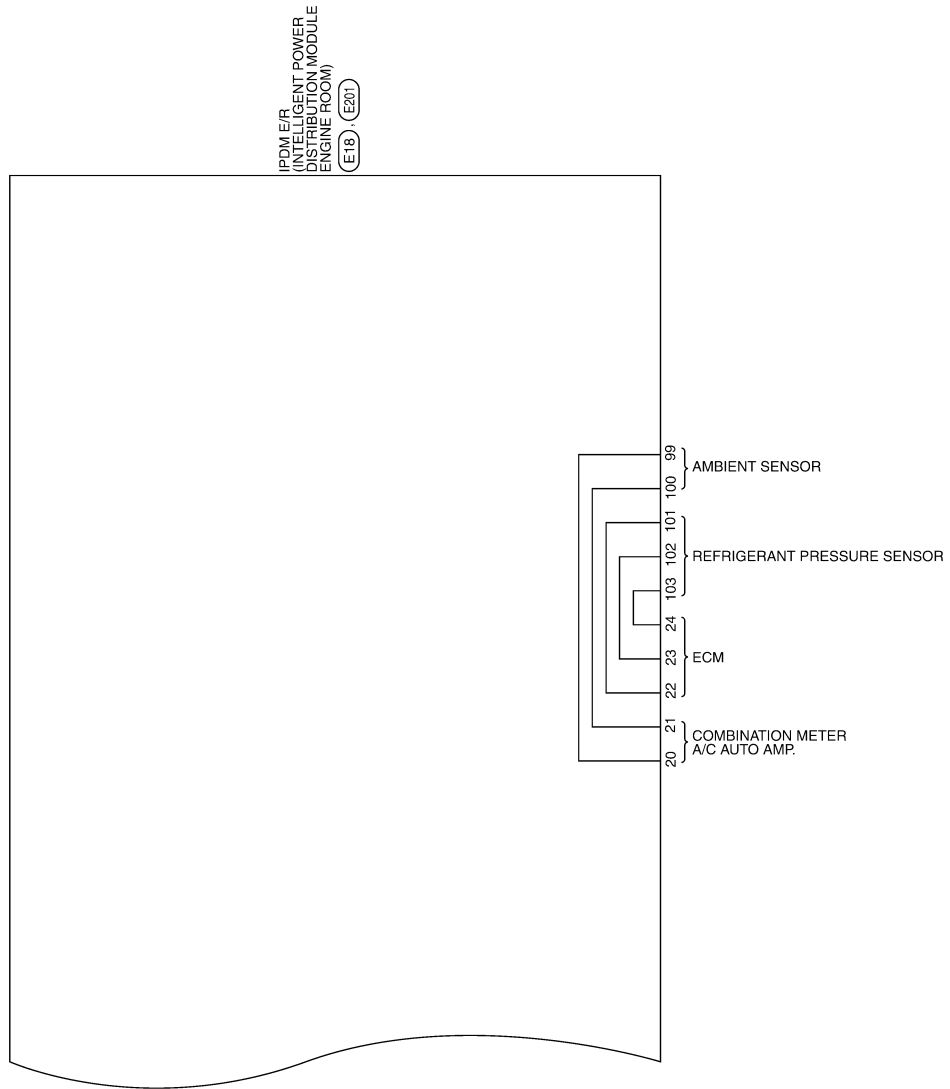

PCS

ABMWA0085GI

IPDM E/R (INTELLIGENT POWER DISTRIBUTION MODULE ENGINE ROOM) CONNECTORS

Connector No.	E1
Connector Name	JOINT CONNECTOR-E01
Connector Color	WHITE



Terminal No.	Color of Wire	Signal Name
2	G	-
3	G	-

Connector No.	E4
Connector Name	FUSIBLE LINK BOX (BATTERY)
Connector Color	BROWN



Terminal No.	Color of Wire	Signal Name
1	B/W	-
2	L	-

Connector No.	E5
Connector Name	FUSIBLE LINK BOX (BATTERY)
Connector Color	GRAY



Terminal No.	Color of Wire	Signal Name
3	R	-

Connector No.	E16
Connector Name	IPDM E/R (INTELLIGENT POWER DISTRIBUTION MODULE ENGINE ROOM)
Connector Color	BLACK



Terminal No.	Color of Wire	Signal Name
1	R	F/L MAIN
2	L	F/L USM

Connector No.	E17
Connector Name	IPDM E/R (INTELLIGENT POWER DISTRIBUTION MODULE ENGINE ROOM)
Connector Color	WHITE

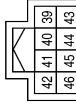

Terminal No.	Color of Wire	Signal Name
39	P	CAN-L
40	L	CAN-H
41	B	GND (SIGNAL)
42	SB	MOTOR FAN RLY MID
43	Y	DETENT SW
44	W	HORN RLY
45	GR	HORN SW
46	BR	START CONT

# IPDM E/R (INTELLIGENT POWER DISTRIBUTION MODULE ENGINE ROOM)

< ECU DIAGNOSIS >

[IPDM E/R]

Connector No.	E18
Connector Name	IPDM E/R (INTELLIGENT POWER DISTRIBUTION MODULE ENGINE ROOM)
Connector Color	WHITE

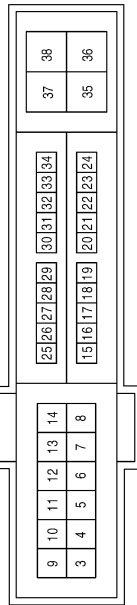

Terminal No.	Color of Wire	Signal Name
3	-	-
4	LG	FR WIPER LO
5	Y	FR WIPER HI
6	L	DTRL/DEICER

Connector No.	E200
Connector Name	IPDM E/R (INTELLIGENT POWER DISTRIBUTION MODULE ENGINE ROOM)
Connector Color	WHITE

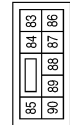

Terminal No.	Color of Wire	Signal Name
83	R/Y	HEADLAMP LO RH
84	L	HEADLAMP LO LH
85	-	-
86	W/R	FR FOG LAMP RH
87	L/Y	FR FOG LAMP LH
88	R/W	WASHER MTR
89	L/W	HEADLAMP HI RH
90	G	HEADLAMP HI LH

Terminal No.	Color of Wire	Signal Name
7	GR	TAIL/ILLUMI
8	-	-
9	-	-
10	BR	ECM VB
11	O	ESCL (EARLY PRODUCTION)
12	B	GND (POWER)
13	SB	FUEL PUMP
14	-	-
15	W	START IG E/R
16	R	WIPER AUTOSTOP
17	-	-
18	-	-
19	Y	BCM IGNSW
20	L	AMB SENS GND-E/R
21	LG	AMB SENS SIG-E/R
22	SB	PD SENS GND-E/R
23	GR	PD SENS SIG-E/R

Terminal No.	Color of Wire	Signal Name
24	G	PD SENS PWR-E/R
25	GR	ABS ECU
26	-	-
27	W	IGN SIGNAL
28	SB	PUSH START SW
29	-	-
30	BR	CLUTCH I/L SW
31	-	-
32	P	SL CONDITION 1 (EARLY PRODUCTION)
33	G	SL CONDITION 2 (EARLY PRODUCTION)
34	O	MOTOR FAN RLY HI
35	P	MOTOR FAN LO
36	G	F/L IGNSW
37	-	-
38	GR	F/L MOTOR FAN

Connector No.	E201
Connector Name	IPDM E/R (INTELLIGENT POWER DISTRIBUTION MODULE ENGINE ROOM)
Connector Color	WHITE

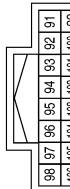

Terminal No.	Color of Wire	Signal Name
91	LG/R	CLEARANCE RH
92	LG/B	CLEARANCE LH
93	-	-
94	-	-
95	-	-
96	-	-
97	-	-

Terminal No.	Color of Wire	Signal Name
98	-	-
99	BR/W	AMB SENS GND-FEM
100	SB	AMB SENS SIG-FEM
101	W	PD SENS GND FEM
102	R	PD SENS SIG FEM
103	P	PD SENS PWR FEM
104	-	-
105	V	DTRL RLY
106	-	-

A  
B  
C  
D  
E  
F  
G  
H  
I  
J  
K  
L  
N  
O  
P

PCS

ABMIA2103GB

# IPDM E/R (INTELLIGENT POWER DISTRIBUTION MODULE ENGINE ROOM)

< ECU DIAGNOSIS >

[IPDM E/R]

Terminal No.	Color of Wire	Signal Name
70	O	MOTRLY
71	-	-
72	R/B	NP SW
73	-	-
74	-	-
75	LG	OIL PRESSURE SW
76	SB	ALT C
77	GR	FPR
78	-	-
79	-	-
80	B/W	STARTER MOTOR

Terminal No.	Color of Wire	Signal Name
47	-	-
48	W	A/C COMP
49	R/G	ING COIL
50	-	-
51	LG	INJECTOR #1
52	Y/G	INJECTOR #2
53	R/W	ENG SOL
54	G/W	ETC
55	W/L	ECM BAT
56	R/Y	O2 SENS #1
57	O	O2 SENS #2
58	Y	AT ECU
59	-	-
60	-	-
61	-	-
62	-	-
63	-	-
64	-	-
65	-	-
66	-	-
67	-	-
68	-	-
69	W/B	SSOFF

Connector No.	F10
Connector Name	IPDM E/R (INTELLIGENT POWER DISTRIBUTION MODULE ENGINE ROOM)
Connector Color	WHITE

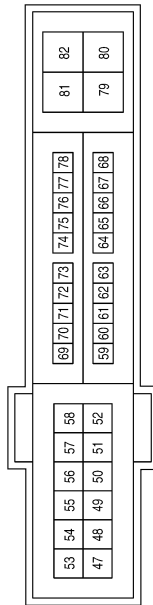

ABMIA1348GB

INFOID:000000005460604

## Fail Safe

### CAN COMMUNICATION CONTROL

When CAN communication with ECM and BCM is impossible, IPDM E/R performs fail-safe control. After CAN communication recovers normally, it also returns to normal control.

If No CAN Communication Is Available With ECM

# IPDM E/R (INTELLIGENT POWER DISTRIBUTION MODULE ENGINE ROOM)

< ECU DIAGNOSIS >

[IPDM E/R]

Control part	Fail-safe in operation
Cooling fan	<ul style="list-style-type: none"> <li>• Signals cooling fans ON when the ignition switch is turned ON</li> <li>• Signals cooling fans OFF when the ignition switch is turned OFF</li> </ul>
A/C compressor	A/C relay OFF
Generator	Outputs the power generation command signal (PWM signal) 0%

If No CAN Communication Is Available With BCM

Control part	Fail-safe in operation
Headlamp	<ul style="list-style-type: none"> <li>• Turns ON the headlamp low relay when the ignition switch is turned ON</li> <li>• Turns OFF the headlamp low relay when the ignition switch is turned OFF</li> <li>• Headlamp high relay OFF</li> </ul>
<ul style="list-style-type: none"> <li>• Parking lamps</li> <li>• License plate lamps</li> <li>• Illumination</li> <li>• Tail lamps</li> </ul>	<ul style="list-style-type: none"> <li>• Turns ON the tail lamp relay when the ignition switch is turned ON</li> <li>• Turns OFF the tail lamp relay when the ignition switch is turned OFF</li> </ul>
Front wiper	<ul style="list-style-type: none"> <li>• The status just before activation of fail-safe control is maintained until the ignition switch is turned OFF while the front wiper is operating at LO or HI speed.</li> <li>• The wiper is operated at LO speed until the ignition switch is turned OFF if the fail-safe control is activated while the front wiper is set in the INT mode and the front wiper motor is operating.</li> </ul>
Front fog lamps (if equipped)	Front fog lamp relay OFF
Horn	Horn OFF
Ignition relay	The status just before activation of fail-safe is maintained.
Starter motor	Starter control relay OFF
Electronic steering column lock <sup>1</sup>	Steering lock relay OFF

1: Early production

## IGNITION RELAY MALFUNCTION DETECTION FUNCTION

- IPDM E/R monitors the voltage at the contact circuit and excitation coil circuit of the ignition relay inside it.
- IPDM E/R judges the ignition relay error if the voltage differs between the contact circuit and the excitation coil circuit.
- If the ignition relay cannot turn OFF due to contact seizure, it activates the tail lamp relay for 10 minutes to alert the user to the ignition relay malfunction when the ignition switch is turned OFF.

DTC	Ignition switch	Ignition relay	Tail lamp relay
—	ON	ON	—
—	OFF	OFF	—
B2098: IGN RELAY ON	OFF	ON	ON (10 minutes)
B2099: IGN RELAY OFF	ON	OFF	—

### NOTE:

The tail lamp turns OFF when the ignition switch is turned ON.

## FRONT WIPER CONTROL

IPDM E/R detects front wiper stop position by a front wiper auto stop signal.

When a front wiper auto stop signal is in the conditions listed below, IPDM E/R stops power supply to wiper after repeating a front wiper 10 second activation and 20 second stop five times.

Ignition switch	Front wiper switch	Auto stop signal
ON	OFF	Front wiper stop position signal cannot be input 10 seconds.
	ON	The signal does not change for 10 seconds.

### NOTE:

A  
B  
C  
D  
E  
F  
G  
H  
I  
J  
K  
L  
N  
O  
P

PCS

# IPDM E/R (INTELLIGENT POWER DISTRIBUTION MODULE ENGINE ROOM)

[IPDM E/R]

## < ECU DIAGNOSIS >

This operation status can be confirmed on the IPDM E/R “Data Monitor” that displays “BLOCK” for the item “WIP PROT” while the wiper is stopped.

### STARTER MOTOR PROTECTION FUNCTION

IPDM E/R turns OFF the starter control relay to protect the starter motor when the starter control relay remains active for 90 seconds.

### DTC Index

INFOID:000000005460605

CONSULT-III display	Fail-safe	TIME <sup>NOTE</sup>		Refer to
No DTC is detected. further testing may be required.	—	—	—	—
U1000: CAN COMM CIRCUIT	×	CRNT	1 – 39	<a href="#">PCS-19</a>
B2098: IGN RELAY ON	×	CRNT	1 – 39	<a href="#">PCS-20</a>
B2099: IGN RELAY OFF	—	CRNT	1 – 39	<a href="#">PCS-21</a>
B2108: STRG LCK RELAY ON	—	CRNT	1 – 39	<a href="#">SEC-92</a>
B2109: STRG LCK RELAY OFF	—	CRNT	1 – 39	<a href="#">SEC-93</a>
B210A: STRG LCK STATE SW	—	CRNT	1 – 39	<a href="#">SEC-94</a>
B210B: START CONT RLY ON	—	CRNT	1 – 39	<a href="#">SEC-98</a>
B210C: START CONT RLY OFF	—	CRNT	1 – 39	<a href="#">SEC-99</a>
B210D: STARTER RELAY ON	—	CRNT	1 – 39	<a href="#">SEC-100</a>
B210E: STARTER RELAY OFF	—	CRNT	1 – 39	<a href="#">SEC-101</a>
B210F: INTRLCK/PNP SW ON	—	CRNT	1 – 39	<a href="#">SEC-103</a>
B2110: INTRLCK/PNP SW OFF	—	CRNT	1 – 39	<a href="#">SEC-105</a>

#### NOTE:

The details of TIME display are as follows.

- CRNT: The malfunctions that are detected now
- 1 - 39: The number is indicated when it is normal at present and a malfunction was detected in the past. It increases like 0 → 1 → 2 ... 38 → 39 after returning to the normal condition whenever IGN OFF → ON. It is fixed to 39 until the self-diagnosis results are erased if it is over 39. It returns to 0 when a malfunction is detected again in the process.

< PRECAUTION >

PRECAUTION

PRECAUTIONS

Precaution for Supplemental Restraint System (SRS) "AIR BAG" and "SEAT BELT PRE-TENSIONER"

INFOID:000000005460606

The Supplemental Restraint System such as "AIR BAG" and "SEAT BELT PRE-TENSIONER", used along with a front seat belt, helps to reduce the risk or severity of injury to the driver and front passenger for certain types of collision. This system includes seat belt switch inputs and dual stage front air bag modules. The SRS system uses the seat belt switches to determine the front air bag deployment, and may only deploy one front air bag, depending on the severity of a collision and whether the front occupants are belted or unbelted. Information necessary to service the system safely is included in the SR and SB section of this Service Manual.

**WARNING:**

- To avoid rendering the SRS inoperative, which could increase the risk of personal injury or death in the event of a collision which would result in air bag inflation, all maintenance must be performed by an authorized NISSAN/INFINITI dealer.
- Improper maintenance, including incorrect removal and installation of the SRS, can lead to personal injury caused by unintentional activation of the system. For removal of Spiral Cable and Air Bag Module, see the SR section.
- Do not use electrical test equipment on any circuit related to the SRS unless instructed to in this Service Manual. SRS wiring harnesses can be identified by yellow and/or orange harnesses or harness connectors.

PRECAUTIONS WHEN USING POWER TOOLS (AIR OR ELECTRIC) AND HAMMERS

**WARNING:**

- When working near the Airbag Diagnosis Sensor Unit or other Airbag System sensors with the Ignition ON or engine running, DO NOT use air or electric power tools or strike near the sensor(s) with a hammer. Heavy vibration could activate the sensor(s) and deploy the air bag(s), possibly causing serious injury.
- When using air or electric power tools or hammers, always switch the Ignition OFF, disconnect the battery, and wait at least 3 minutes before performing any service.

Precautions Necessary for Steering Wheel Rotation after Battery Disconnect (Early Production, With Electronic Steering Column Lock)

INFOID:0000000055885966

**NOTE:**

- Before removing and installing any control units, first turn the push-button ignition switch to the LOCK position, then disconnect both battery cables.
- After finishing work, confirm that all control unit connectors are connected properly, then re-connect both battery cables.
- Always use CONSULT-III to perform self-diagnosis as a part of each function inspection after finishing work. If a DTC is detected, perform trouble diagnosis according to self-diagnosis results.

This vehicle is equipped with a push-button ignition switch and a steering lock unit.

If the battery is disconnected or discharged, the steering wheel will lock and cannot be turned.

If turning the steering wheel is required with the battery disconnected or discharged, follow the procedure below before starting the repair operation.

OPERATION PROCEDURE

1. Connect both battery cables.

**NOTE:**

Supply power using jumper cables if battery is discharged.

2. Carry the Intelligent Key or insert it to the key slot and turn the push-button ignition switch to ACC position. (At this time, the steering lock will be released.)
3. Disconnect both battery cables. The steering lock will remain released with both battery cables disconnected and the steering wheel can be turned.
4. Perform the necessary repair operation.

A  
B  
C  
D  
E  
F  
G  
H  
I  
J  
K  
L  
N  
O  
P



## PRECAUTIONS

[IPDM E/R]

### < PRECAUTION >

5. When the repair work is completed, re-connect both battery cables. With the brake pedal released, turn the push-button ignition switch from ACC position to ON position, then to LOCK position. (The steering wheel will lock when the push-button ignition switch is turned to LOCK position.)
6. Perform self-diagnosis check of all control units using CONSULT-III.

### Precaution for Procedure without Cowl Top Cover

INFOID:000000005460608

When performing the procedure after removing cowl top cover, cover the lower end of windshield with urethane, etc.

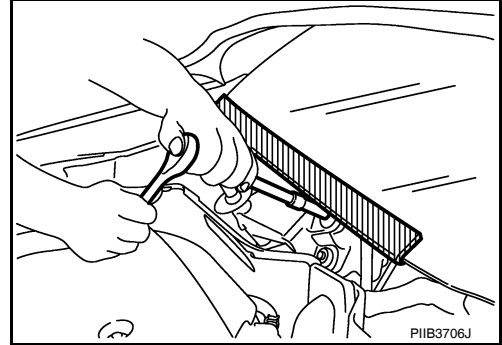



## ON-VEHICLE REPAIR

### IPDM E/R (INTELLIGENT POWER DISTRIBUTION MODULE ENGINE ROOM)

#### Removal and Installation

INFOID:000000005460609

#### REMOVAL

1. Disconnect battery negative terminal.
2. Remove the IPDM E/R cover (1) while pressing the pawl (A) at the rear end of the IPDM E/R cover (1).

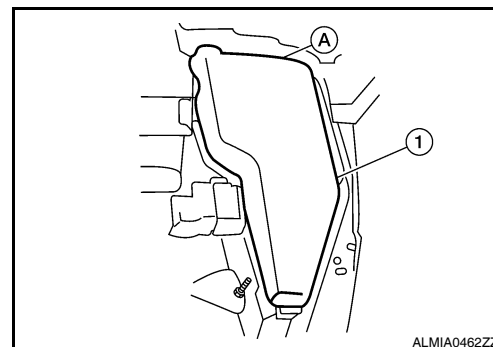

3. Disconnect the harness connectors from the IPDM E/R.

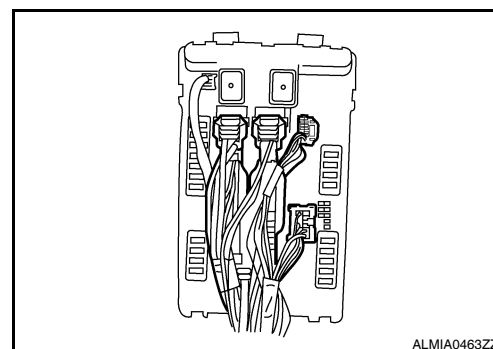

4. While depressing the tabs (A) remove the IPDM E/R (1) from the vehicle.

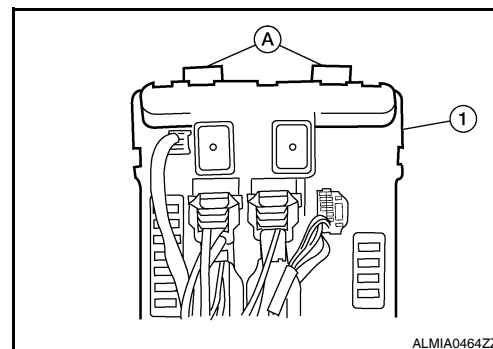

#### INSTALLATION

Installation is in the reverse order of removal.

A  
B  
C  
D  
E  
F  
G  
H  
I  
J  
K  
L  
N  
O  
P

PCS

# DIAGNOSIS AND REPAIR WORKFLOW

< BASIC INSPECTION >

[POWER DISTRIBUTION SYSTEM]

## BASIC INSPECTION

### DIAGNOSIS AND REPAIR WORKFLOW

Work Flow

INFOID:000000005460610

OVERALL SEQUENCE

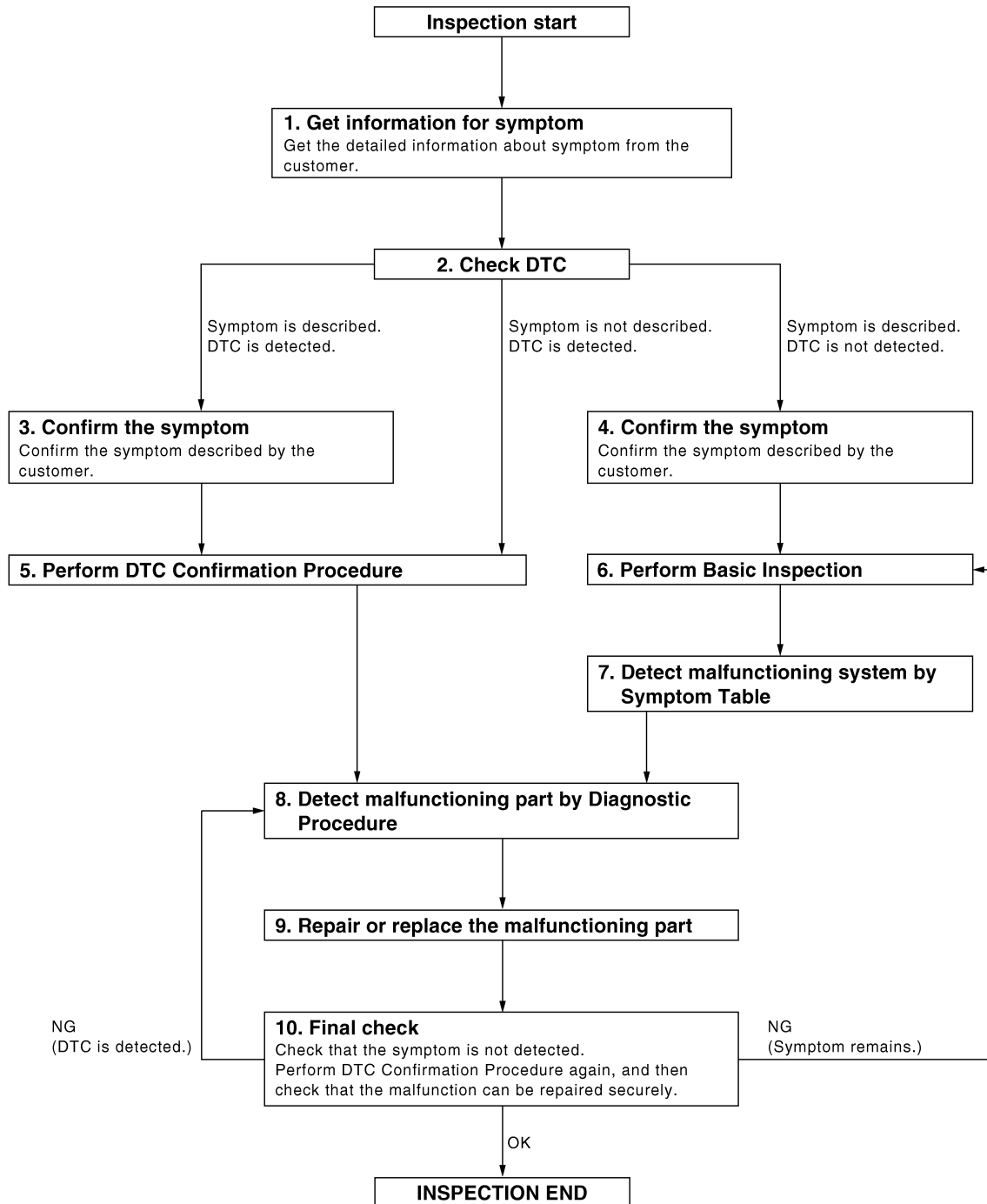

DETAILED FLOW

JMKIA0101GB

# DIAGNOSIS AND REPAIR WORKFLOW

< BASIC INSPECTION >

[POWER DISTRIBUTION SYSTEM]

## 1. GET INFORMATION FOR SYMPTOM

Get the detailed information from the customer about the symptom (the condition and the environment when the incident/malfunction occurred).

>> GO TO 2

## 2. CHECK DTC

1. Check DTC.
2. Perform the following procedure if DTC is displayed.
  - Record DTC and freeze frame data (Print them out with CONSULT-III.)
  - Erase DTC.
  - Study the relationship between the cause detected by DTC and the symptom described by the customer.
3. Check related service bulletins for information.

Is any symptom described and any DTC detected?

Symptom is described, DTC is displayed>>GO TO 3

Symptom is described, DTC is not displayed>>GO TO 4

Symptom is not described, DTC is displayed>>GO TO 5

## 3. CONFIRM THE SYMPTOM

Confirm the symptom described by the customer.

Connect CONSULT-III to the vehicle in "DATA MONITOR" mode and check real time diagnosis results. Verify relation ship between the symptom and the condition when the symptom is detected.

>> GO TO 5

## 4. CONFIRM THE SYMPTOM

Confirm the symptom described by the customer.

Connect CONSULT-III to the vehicle in "DATA MONITOR" mode and check real time diagnosis results. Verify relation between the symptom and the condition when the symptom is detected.

>> GO TO 6

## 5. PERFORM DTC CONFIRMATION PROCEDURE

Perform DTC Confirmation Procedure for the displayed DTC, and then check that DTC is detected again. At this time, always connect CONSULT-III to the vehicle, and check diagnostic results in real time.

If two or more DTCs are detected, refer to [PCS-111, "DTC Inspection Priority Chart"](#) and determine trouble diagnosis order.

### NOTE:

- Freeze frame data is useful if the DTC is not detected.
- Perform Component Function Check if DTC Confirmation Procedure is not included in Service Manual. This simplified check procedure is an effective alternative though DTC cannot be detected during this check. If the result of Component Function Check is NG, it is the same as the detection of DTC by DTC Confirmation Procedure.

Is DTC detected?

YES >> GO TO 8

NO >> Refer to [GI-39, "Intermittent Incident"](#).

## 6. PERFORM BASIC INSPECTION

Perform a basic inspection of the IPDM E/R.

Inspection End>>GO TO 7

## 7. DETECT MALFUNCTIONING SYSTEM BY SYMPTOM TABLE

Detect malfunctioning system according to [PCS-132, "Symptom Table"](#) based on the confirmed symptom in step 4, and determine the trouble diagnosis order based on possible causes and symptom.

>> GO TO 8

A  
B  
C  
D  
E  
F  
G  
H  
I  
J  
K  
L

PCS

N  
O  
P

# DIAGNOSIS AND REPAIR WORKFLOW

## [POWER DISTRIBUTION SYSTEM]

< BASIC INSPECTION >

### 8. DETECT MALFUNCTIONING PART BY DIAGNOSTIC PROCEDURE

Inspect according to Diagnostic Procedure of the system.

**NOTE:**

The Diagnostic Procedure described based on open circuit inspection. A short circuit inspection is also required for the circuit check in the Diagnostic Procedure.

Is malfunctioning part detected?

YES >> GO TO 9

NO >> Check voltage of related BCM terminals using CONSULT-III.

### 9. REPAIR OR REPLACE THE MALFUNCTIONING PART

1. Repair or replace the malfunctioning part.
2. Reconnect parts or connectors disconnected during Diagnostic Procedure again after repair and replacement.
3. Check DTC. If DTC is displayed, erase it.

>> GO TO 10

### 10. FINAL CHECK

When DTC was detected in step 2, perform DTC Confirmation Procedure or Component Function Check again, and then check that the malfunction have been fully repaired.

When symptom was described from the customer, refer to confirmed symptom in step 3 or 4 and check that the symptom is not detected.

Is the inspection result normal?

YES >> Inspection End.

NO (DTC is detected)>>GO TO 8

NO (Symptom remains)>>GO TO 6

### Pre-Inspection for Multi-System Diagnostic

INFOID:000000005460611

The engine start function, door lock function, power distribution system and NATS-IVIS/NVIS are closely related to each other. Narrow down the system in question by performing this inspection to identify which system is malfunctioning. For example, the vehicle security system can operate only when the door lock and power distribution system are operating normally.

#### 1. CHECK DOOR LOCK OPERATION

Check the door lock for normal operation with the Intelligent Key and door request switch.

Successful door lock operation with the Intelligent Key and request switch indicates that the remote keyless entry receiver and inside key antenna required for engine start are functioning normally.

Can the door be locked with the Intelligent Key and door request switch?

YES >> GO TO 2.

NO >> Refer to [DLK-186. "Symptom Table"](#).

#### 2. CHECK ENGINE STARTING

Check that the engine starts when the Intelligent Key is inserted into the key slot.

Does the engine start?

YES >> • Early production: GO TO 3.

• Late production: GO TO 4.

NO >> Refer to [SEC-191. "Symptom Table"](#).

#### 3. CHECK STEERING LOCK OPERATION

Check that the steering locks when operating the door switch after switching the power supply from ON position (or ACC position) to LOCK position.

If the door switch is malfunctioning, BCM cannot lock the steering. If BCM does not detect DTC, steering lock unit is normal.

Does steering lock?

YES >> GO TO 4.

NO >> Refer to [DLK-68. "Component Function Check"](#).

# DIAGNOSIS AND REPAIR WORKFLOW

## [POWER DISTRIBUTION SYSTEM]

< BASIC INSPECTION >

### 4.CHECK POWER SUPPLY INDICATOR SWITCHING

Press push-button ignition switch and check that the position indicator switches from LOCK, through ACC to ON when steering is locked.

Is each position indicator illuminating?

YES >> GO TO 5.

NO >> Refer to [PCS-75, "Component Function Check"](#).

### 5.CHECK VEHICLE SECURITY SYSTEM

Check the vehicle security system for normal operation. Refer to [SEC-8, "Vehicle Security Operation Check"](#).

Are the inspection results normal?

YES >> Inspection End.

NO >> Repair vehicle security system as necessary.

A  
B  
C  
D  
E  
F  
G  
H  
I  
J  
K  
L  
N  
O  
P

PCS

# POWER DISTRIBUTION SYSTEM

< FUNCTION DIAGNOSIS >

[POWER DISTRIBUTION SYSTEM]

## FUNCTION DIAGNOSIS

### POWER DISTRIBUTION SYSTEM

#### System Description

INFOID:000000005460612

#### INPUT/OUTPUT SIGNAL CHART

Switch	Input Signal to BCM	BCM system	Actuator
Push-button ignition switch	Push switch	Power distribution system	<ul style="list-style-type: none"> <li>• Ignition relay (IPDM E/R)</li> <li>• Ignition relay (fuse block)</li> <li>• ACC relay</li> <li>• Front blower motor relay</li> </ul>
CVT shift selector	P range		
Transmission range switch	N, P range		
Stop lamp switch	Brake ON/OFF		

#### SYSTEM DESCRIPTION

- POWER DISTRIBUTION SYSTEM (PDS) is the system that BCM controls with the operation of the push-button ignition switch and performs the power distribution to each power circuit. This system is used instead of the mechanical power supply changing mechanism with the operation of the conventional key cylinder.
- The push-button ignition switch can be operated when Intelligent Key is in the following conditions. Refer to Engine Start Function for details.
  - Intelligent Key is in the detection area of the interior antenna
  - Insert Intelligent Key in to the key slot
- The push-button ignition switch operation is input to BCM as a signal. BCM changes the power supply position according to the status and operates the following relays to supply power to each power circuit.
  - Ignition relay (inside IPDM E/R)
  - Ignition relay (inside fuse block)
  - ACC relay
  - Front blower motor relay

#### NOTE:

- The engine switch operation changes due to the conditions of brake pedal, CVT selector lever and vehicle speed.
- The power supply position can be confirmed with the lighting of the indicators near the push-button ignition switch.

#### PUSH-BUTTON IGNITION SWITCH OPERATION PROCEDURE

The power supply position changing operation can be performed with the following operation.

#### NOTE:

- When an Intelligent Key is within the detection area of inside key antenna and when it is inserted in to the key slot, it is equivalent to the operations below.
- When starting the engine, the BCM monitors under the engine start conditions,
  - Brake pedal operating condition
  - CVT selector lever position
  - Vehicle speed
- Unless each start condition is fulfilled, the engine will not respond regardless of how many times the engine switch is pressed. At that time, illumination repeats the position in the order of LOCK→ACC→ON→OFF.

Power supply position	Engine start/stop condition		Push-button ignition switch operation frequency
	Brake pedal	CVT selector lever position	
LOCK → ACC	Not depressed	Any position	1
LOCK → ACC → ON	Not depressed	Any position	2
LOCK → ACC → ON → OFF	Not depressed	Any position	3
LOCK → START ACC → START ON → START (Engine start)	Depressed	P or N position (*1)	1 [If the switch is pressed once, the engine starts from any power supply position (LOCK, ACC, and ON)]

# POWER DISTRIBUTION SYSTEM

< FUNCTION DIAGNOSIS >

[POWER DISTRIBUTION SYSTEM]

Power supply position	Engine start/stop condition		Push-button ignition switch operation frequency
	Brake pedal	CVT selector lever position	
Engine is running → OFF (Engine stop)	—	Any position	1
Engine is running → ACC (Engine stop)	—	Any position other than P (*2)	1
Engine stall return operation while driving	—	N position	1

\*1: When the CVT selector lever position is N position, the engine start condition is different according to the vehicle speed.

- At vehicle speed of 4 km/h (2 MPH) or less, the engine can start only when the brake pedal is depressed.
- At vehicle speed of 4 km/h (2 MPH) or more, the engine can start even if the brake pedal is not depressed. (It is the same as “Engine stall return operation while driving”.)

\*2: When the CVT selector lever position is in any position other than P position and when the vehicle speed is 5 km/h or more, the engine stop condition is different.

- Press and hold the push-button ignition switch for 2 seconds or more. (When the push-button ignition switch is pressed for too short a time, the operation may be invalid, so properly press and hold to prevent the incorrect operation.)
- Press the push-button ignition switch 3 times or more within 1.5 seconds. (Emergency stop operation)

## Component Parts Location

INFOID:000000005460613

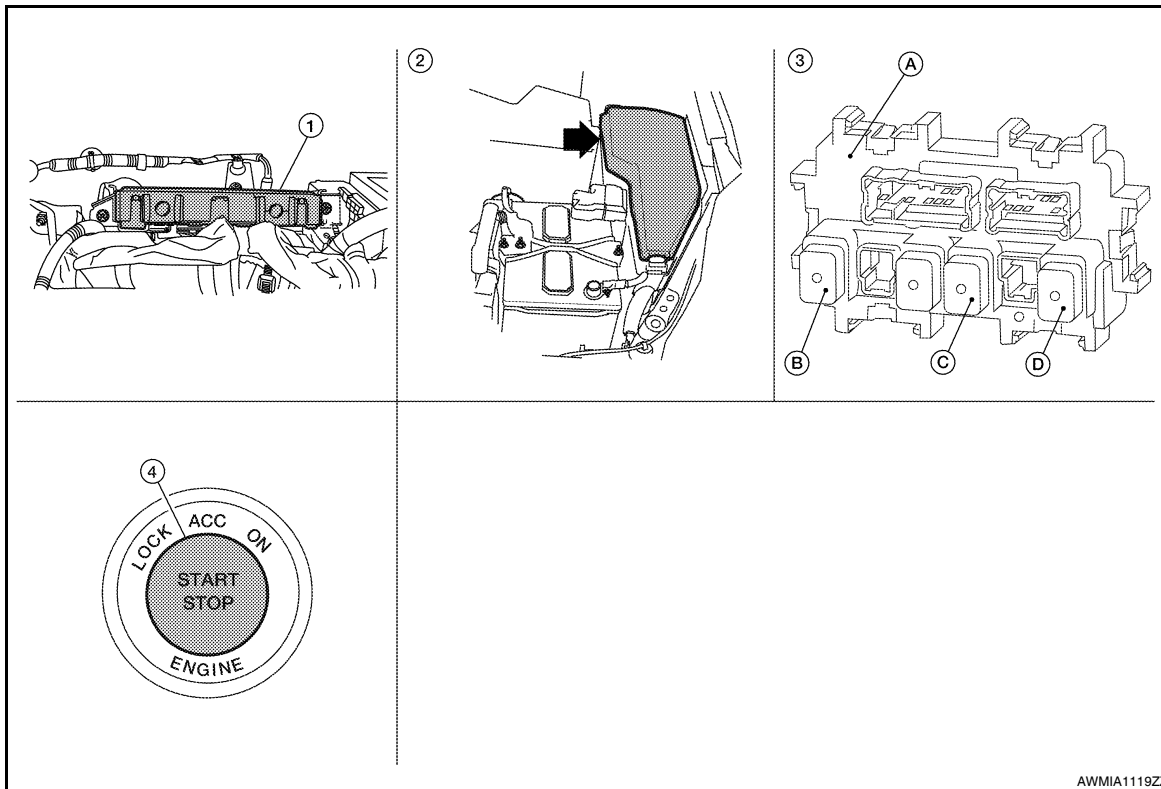

1. BCM M16, M17, M18, M19, M21 (view with instrument panel removed)
2. IPDM E/R E16, E17, E18 (contains IGN relay-1)
3. A. Fuse block (J/B) M3, M4, M5, E6  
B. IGN relay-2  
C. ACC relay  
D. Front blower motor relay
4. Push-button ignition switch M38

# POWER DISTRIBUTION SYSTEM

< FUNCTION DIAGNOSIS >

[POWER DISTRIBUTION SYSTEM]

## Component Description

INFOID:000000005460614

BCM	Reference
IPDM E/R	<a href="#">PCS-7. "System Diagram"</a>
Ignition relay-1 (Built-in IPDM E/R)	<a href="#">PCS-68. "Description"</a>
Ignition relay-2 (Built-in fuse block)	<a href="#">PCS-65. "Description"</a>
Accessory relay	<a href="#">PCS-59. "Description"</a>
Front blower motor relay	<a href="#">PCS-62. "Description"</a>
Stop lamp	<a href="#">SEC-49. "Description"</a>
Transmission range switch	<a href="#">SEC-65. "Description"</a>
Push-button ignition switch	<a href="#">SEC-52. "Description"</a>



# DIAGNOSIS SYSTEM (BCM)

[POWER DISTRIBUTION SYSTEM]

< FUNCTION DIAGNOSIS >

## DIAGNOSIS SYSTEM (BCM)

### COMMON ITEM

#### COMMON ITEM : CONSULT-III Function

INFOID:000000005511876

#### ECU IDENTIFICATION

Displays the BCM part No.

#### SELF-DIAG RESULT

Refer to [PCS-113, "DTC Index"](#).

### INTELLIGENT KEY

#### INTELLIGENT KEY : CONSULT-III Function (BCM - INTELLIGENT KEY)

INFOID:000000005511877

#### WORK SUPPORT

Monitor item	Description
CONFIRM KEY FOB ID	It can be checked whether Intelligent Key ID code is registered or not in this mode.
AUTO LOCK SET	Auto door lock time can be changed in this mode. <ul style="list-style-type: none"> <li>• MODE 1: 1 minute</li> <li>• MODE 2: 5 minutes</li> <li>• MODE 3: 30 seconds</li> <li>• MODE 4: 2 minutes</li> </ul>
LOCK/UNLOCK BY I-KEY	Door lock/unlock function by door request switch (driver side, passenger side and trunk) mode can be changed to operate (ON) or not operate (OFF) with this mode.
ENGINE START BY I-KEY	Engine start function mode can be changed to operate (ON) or not operate (OFF) with this mode.
TRUNK/GLASS HATCH OPEN	Buzzer reminder function mode by trunk opener request switch can be changed to operate (ON) or not operate (OFF) with this mode.
PANIC ALARM SET	Panic alarm button pressing time on Intelligent Key remote control button can be selected from the following with this mode. <ul style="list-style-type: none"> <li>• MODE 1: 0.5 sec.</li> <li>• MODE 2: OFF: Non-operation</li> <li>• MODE 3: 1.5 sec.</li> </ul>
PW DOWN SET	Unlock button pressing time on Intelligent Key button to lower front windows can be selected from the following with this mode. <ul style="list-style-type: none"> <li>• MODE 1: 3 sec.</li> <li>• MODE 2: OFF: Non-operation</li> <li>• MODE 3: 5 sec.</li> </ul>
TRUNK OPEN DELAY	Trunk button pressing time on Intelligent Key button can be selected from the following with this mode. <ul style="list-style-type: none"> <li>• MODE 1: 0.5 sec.</li> <li>• MODE 2: OFF: No delay</li> <li>• MODE 3: 1.5 sec.</li> </ul>
LO- BATT OF KEY FOB WARN	Intelligent Key low battery warning mode can be changed to operate (ON) or not operate (OFF) with this mode.
ANTI KEY LOCK IN FUNCTI	Key reminder function mode can be changed to operate (ON) or not operate (OFF) with this mode.
HAZARD ANSWER BACK	Hazard reminder function mode can be selected from the following with this mode. <ul style="list-style-type: none"> <li>• LOCK ONLY: Door lock operation only</li> <li>• UNLOCK ONLY: Door unlock operation only</li> <li>• LOCK AND UNLOCK: Lock/unlock operation</li> <li>• OFF: Non operation</li> </ul>
ANS BACK I-KEY LOCK	Buzzer reminder function (lock operation) mode by door request switch (driver side and passenger side) can be selected from the following with this mode. <ul style="list-style-type: none"> <li>• HORN CHIRP: Sound horn</li> <li>• BUZZER: Sound Intelligent Key warning buzzer</li> <li>• OFF: Non-operation</li> </ul>

# DIAGNOSIS SYSTEM (BCM)

< FUNCTION DIAGNOSIS >

[POWER DISTRIBUTION SYSTEM]

Monitor item	Description
ANS BACK I-KEY UNLOCK	Buzzer reminder function (unlock operation) mode by door request switch can be changed to operate (ON) or not operate (OFF) with this mode.
SHORT CRANKING OUTPUT	Starter motor can operate during the times below. <ul style="list-style-type: none"> <li>• 70 msec</li> <li>• 100 msec</li> <li>• 200 msec</li> </ul>
INSIDE ANT DIAGNOSIS	This function allows inside key antenna self-diagnosis.
HORN WITH KEYLESS LOCK	Horn reminder function mode by Intelligent Key button can be changed to operate (ON) or not operate (OFF) with this mode.

## SELF-DIAG RESULT

Refer to [PCS-113, "DTC Index"](#).

## DATA MONITOR

Monitor Item	Condition
REQ SW-DR	Indicates [ON/OFF] condition of door request switch (driver side).
REQ SW-AS	Indicates [ON/OFF] condition of door request switch (passenger side).
REQ SW-BD/TR	Indicates [ON/OFF] condition of trunk opener request switch.
PUSH SW	Indicates [ON/OFF] condition of push button ignition switch.
IGN RLY2-F/B	Indicates [ON/OFF] condition of ignition relay 2.
ACC RLY-F/B	Indicates [ON/OFF] condition of accessory relay.
BRAKE SW 1	Indicates [ON/OFF] condition of brake switch.
BRAKE SW 2	Indicates [ON/OFF] condition of brake switch.
DETE/CANCL SW	Indicates [ON/OFF] condition of P position.
SFT PN/N SW	Indicates [ON/OFF] condition of P or N position.
S/L -LOCK*	Indicates [ON/OFF] condition of steering lock (LOCK).
S/L -UNLOCK*	Indicates [ON/OFF] condition of steering lock (UNLOCK).
S/L RELAY-F/B*	Indicates [ON/OFF] condition of ignition switch.
UNLK SEN-DR	Indicates [ON/OFF] condition of driver door UNLOCK status.
PUSH SW -IPDM	Indicates [ON/OFF] condition of push button ignition switch from IPDM E/R via CAN.
IGN RLY1-F/B	Indicates [ON/OFF] condition of ignition relay 1 from IPDM E/R via CAN.
DETE SW -IPDM	Indicates [ON/OFF] condition of P position from TCM via CAN.
SFT PN -IPDM	Indicates [ON/OFF] condition of P or N position from TCM via CAN.
SFT P -MET	Indicates [ON/OFF] condition of P position from TCM via CAN.
SFT N -MET	Indicates [ON/OFF] condition of N position from IPDM E/R via CAN.
ENGINE STATE	Indicates [STOP/START/CRANK/RUN] condition of engine states from ECM via CAN.
S/L LOCK-IPDM*	Indicates [ON/OFF] condition of steering lock (LOCK) request from IPDM E/R via CAN.
S/L UNLK-IPDM*	Indicates [ON/OFF] condition of steering lock (UNLOCK) request from IPDM E/R via CAN.
S/L RELAY-REQ*	Indicates [ON/OFF] condition of steering lock relay from IPDM E/R via CAN.
VEH SPEED 1	Display the vehicle speed signal received from combination meter by numerical value [km/h].
VEH SPEED 2	Display the vehicle speed signal received from ABS or VDC or CVT by numerical value [km/h].
DOOR STAT-DR	Indicates [LOCK/READY/UNLK] condition of driver side door status.
DOOR STAT-AS	Indicates [LOCK/READY/UNLK] condition of passenger side door status.
ID OK FLAG	Indicates [SET/RESET] condition of key ID.
PRMT ENG STRT	Indicates [SET/RESET] condition of engine start possibility.
KEY SW -SLOT	Indicates [ON/OFF] condition of key slot.

# DIAGNOSIS SYSTEM (BCM)

< FUNCTION DIAGNOSIS >

[POWER DISTRIBUTION SYSTEM]

Monitor Item	Condition
TRNK/HAT MNTR	Indicates [ON/OFF] condition of trunk lid.
RKE-LOCK	Indicates [ON/OFF] condition of LOCK signal from Intelligent Key.
RKE-UNLOCK	Indicates [ON/OFF] condition of UNLOCK signal from Intelligent Key.
RKE-TR/BD	Indicates [ON/OFF] condition of TRUNK OPEN signal from Intelligent Key.
RKE-PANIC	Indicates [ON/OFF] condition of PANIC button of Intelligent Key.
RKE-P/W OPEN	Indicates [ON/OFF] condition of P/W DOWN signal from Intelligent Key.
RKE-MODE CHG	Indicates [ON/OFF] condition of MODE CHANGE signal from Intelligent Key.
RKE OPE COUN1	When remote keyless entry receiver receives the signal transmitted while operating on Intelligent Key, the numerical value start changing.
REVERSE SW	Indicates [ON/OFF] condition of reverse switch status.

\* : With electronic steering column lock

## ACTIVE TEST

Test item	Description
BATTERY SAVER	This test is able to check interior room lamp operation. The interior room lamp will be activated after "ON" on CONSULT-III screen is touched.
PW REMOTO DOWN SET	This test is able to check power window down operation. The power window down will be activated after "ON" on CONSULT-III screen is touched.
OUTSIDE BUZZER	This test is able to check Intelligent Key warning buzzer operation. Intelligent Key warning buzzer sounds when "ON" on CONSULT-III screen is touched.
INSIDE BUZZER	This test is able to check warning chime by combination meter operation. <ul style="list-style-type: none"> <li>• Take out warning chime sounds when "TAKE OUT" on CONSULT-III screen is touched.</li> <li>• Key warning chime sounds when "KEY WARN" on CONSULT-III screen is touched.</li> <li>• P position warning chime sounds when "P RNG WARN" on CONSULT-III screen is touched.</li> <li>• ACC warning chime sounds when "ACC WARN" on CONSULT-III screen is touched.</li> </ul>
INDICATOR	This test is able to check warning lamp operation. <ul style="list-style-type: none"> <li>• "KEY" Warning lamp illuminates when "KEY IND ON" on CONSULT-III screen is touched.</li> <li>• "KEY" Warning lamp flashes when "KEY IND FSH" on CONSULT-III screen is touched.</li> </ul>
INT LAMP	This test is able to check interior room lamp operation. The interior room lamp will be activated after "ON" on CONSULT-III screen is touched.
LCD	This test is able to check meter display information <ul style="list-style-type: none"> <li>• Engine start information displays when "BRAKE/P" on CONSULT-III screen is touched.</li> <li>• Engine start information displays when "BRAKE/P/ON" on CONSULT-III screen is touched.</li> <li>• Key ID warning displays when "KEY ID NG" on CONSULT-III screen is touched.</li> <li>• Steering lock information displays when "STLCK RELES" on CONSULT-III screen is touched.*</li> <li>• P position warning displays when "P RNG IND" on CONSULT-III screen is touched.</li> <li>• Intelligent Key insert information displays when "INSERT KEY" on CONSULT-III screen is touched.</li> <li>• Intelligent Key low battery warning displays when "KEY BAT LOW" on CONSULT-III screen is touched.</li> <li>• Take away window warning displays when "TK AWAY WDW" on CONSULT-III screen is touched.</li> <li>• Take away warning display when "TAKE AWAY" on CONSULT-III screen is touched.</li> <li>• OFF position warning display when "IGN OFF WARN" on CONSULT-III screen is touched.</li> </ul>
TRUNK/GLASS HATCH	This test is able to check trunk lid opener actuator open operation. This actuator opens when "ON" on CONSULT-III screen is touched.
FLASHER	This test is able to check security hazard lamp operation. The hazard lamps will be activated after "ON" on CONSULT-III screen is touched.
HORN	This test is able to check horn operation. The horn will be activated after "ON" on CONSULT-III screen is touched.
P RANGE	This test is able to check CVT shift selector power supply CVT shift selector power is supplied when "ON" on CONSULT-III screen is touched.
ENGINE SW ILLUMI	This test is able to check push-ignition switch illumination operation. Push-ignition switch illumination illuminates when "ON" on CONSULT-III screen is touched.

A  
B  
C  
D  
E  
F  
G  
H  
I  
J  
K  
L  
PCS  
N  
O  
P

# DIAGNOSIS SYSTEM (BCM)

## [POWER DISTRIBUTION SYSTEM]

### < FUNCTION DIAGNOSIS >

Test item	Description
LOCK INDICATOR	This test is able to check LOCK indicator in push-ignition switch operation. LOCK indicator in push-ignition switch illuminates when "ON" on CONSULT-III screen is touched.
ACC INDICATOR	This test is able to check ACC indicator in push-ignition switch operation. LOCK indicator in push-ignition switch illuminates when "ON" on CONSULT-III screen is touched.
IGNITION ON IND	This test is able to check IGNITION ON indicator in push-ignition switch operation. LOCK indicator in push-ignition switch illuminates when "ON" on CONSULT-III screen is touched.
KEY SLOT ILLUMI	This test is able to check key slot illumination operation. Key slot illumination flash when "ON" on CONSULT-III screen is touched.
TRUNK/BACK DOOR	This test is able to check trunk lid opener actuator open operation. This actuator opens when "ON" on CONSULT-III screen is touched.

\* : With electronic steering column lock

# U1000 CAN COMM CIRCUIT

< COMPONENT DIAGNOSIS >

[POWER DISTRIBUTION SYSTEM]

## COMPONENT DIAGNOSIS

### U1000 CAN COMM CIRCUIT

#### Description

INFOID:000000005460617

Refer to [LAN-25, "CAN Communication Signal Chart"](#).

#### DTC Logic

INFOID:000000005460618

#### DTC DETECTION LOGIC

CONSULT-III display description	DTC Detection Condition	Possible cause
CAN COMM CIRCUIT [U1000]	When IPDM E/R cannot communicate CAN communication signal continuously for 2 seconds or more	In CAN communication system, any item (or items) listed below is malfunctioning. <ul style="list-style-type: none"><li>• Transmission</li><li>• Receiving (ECM)</li><li>• Receiving (VDC/TCS/ABS)</li><li>• Receiving (METER/M&amp;A)</li><li>• Receiving (TCM)</li><li>• Receiving (MULTI AV)</li><li>• Receiving (IPDM E/R)</li></ul>

#### Diagnosis Procedure

INFOID:000000005460619

#### 1. PERFORM SELF DIAGNOSTIC

1. Turn ignition switch ON and wait for 2 seconds or more.
2. Check "Self Diagnostic Result".

Is "CAN COMM CIRCUIT" displayed?

- YES >> Refer to [LAN-25, "CAN Communication Signal Chart"](#).  
NO >> Refer to [GI-39, "Intermittent Incident"](#).

A  
B  
C  
D  
E  
F  
G  
H  
I  
J  
K  
L  
N  
O  
P

PCS

# U1010 CONTROL UNIT (CAN)

< COMPONENT DIAGNOSIS >

[POWER DISTRIBUTION SYSTEM]

## U1010 CONTROL UNIT (CAN)

### DTC Logic

INFOID:000000005460620

### DTC DETECTION LOGIC

CONSULT-III display description	DTC Detection Condition	Possible cause
CAN COMM CIRCUIT [U1010]	BCM detected internal CAN communication circuit malfunction.	BCM

### Diagnosis Procedure

INFOID:000000005460621

#### 1. REPLACE BCM

When DTC U1010 is detected, replace BCM.

>> Replace BCM. Refer to [BCS-87, "Removal and Installation"](#).

# B2553 IGNITION RELAY

< COMPONENT DIAGNOSIS >

[POWER DISTRIBUTION SYSTEM]

## B2553 IGNITION RELAY

### Description

INFOID:000000005460622

BCM turns ON the following relays to ignition power supply to each ECU when the ignition switch is turned ON.

- Ignition relay-1 (inside IPDM E/R)
- Ignition relay-2 (inside fuse block)
- Front blower motor relay

BCM checks any ignition relay ON request for consistency with the actual ignition relay operation status.

### DTC Logic

INFOID:000000005460623

### DTC DETECTION LOGIC

DTC No.	Trouble diagnosis name	DTC detecting condition	Possible cause
B2553	IGNITION RELAY	BCM detects a difference of signal for 2 seconds or more between the following information. <ul style="list-style-type: none"> <li>• Ignition relay-2 (fuse block) ON/OFF operation</li> <li>• Ignition relay-2 (fuse block) feedback.</li> </ul>	<ul style="list-style-type: none"> <li>• Harness or connectors (ignition relay-2 feedback circuit is open or short)</li> </ul>

### DTC CONFIRMATION PROCEDURE

#### 1. PERFORM DTC CONFIRMATION PROCEDURE

1. Turn ignition switch ON under the following conditions, and wait for at least 2 seconds.
  - CVT selector lever is in the P or N position.
  - Release brake pedal.
2. Check "Self diagnostic result" with CONSULT-III.

#### Is DTC detected?

- YES >> Go to [PCS-55, "Diagnosis Procedure"](#).  
 NO >> Inspection End.

### Diagnosis Procedure

INFOID:000000005460624

Regarding Wiring Diagram information, refer to [PCS-123, "Wiring Diagram"](#).

#### 1. CHECK IGNITION RELAY FEEDBACK INPUT SIGNAL

Check voltage between BCM harness connector and ground under the following conditions.

Terminals		Condition	Voltage (V)
(+)	(-)		
BCM		Ignition switch	0 Battery voltage
Connector	Terminal		
M18	31		

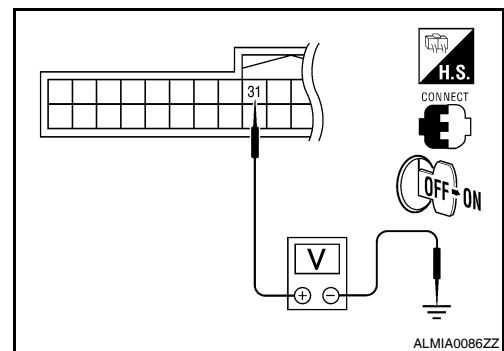

#### Is the inspection result normal?

- YES >> Replace BCM. Refer to [BCS-87, "Removal and Installation"](#).  
 NO >> GO TO 2

#### 2. CHECK IGNITION RELAY FEEDBACK CIRCUIT

# B2553 IGNITION RELAY

## [POWER DISTRIBUTION SYSTEM]

### < COMPONENT DIAGNOSIS >

1. Turn ignition switch OFF.
2. Disconnect BCM and fuse block (J/B).
3. Check continuity between BCM harness connector and fuse block harness connector.

BCM		Fuse block		Continuity
Connector	Terminal	Connector	Terminal	
M18 (A)	31	M3 (B)	2N	Yes

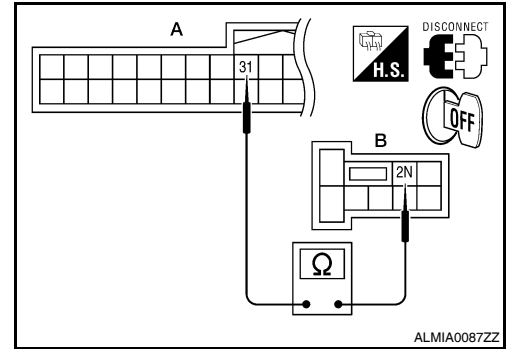

4. Check continuity between BCM harness connector and ground.

BCM		Ground	Continuity
Connector	Terminal		
M18	31		No

Is the inspection result normal?

- YES >> GO TO 3  
 NO >> Repair or replace harness.

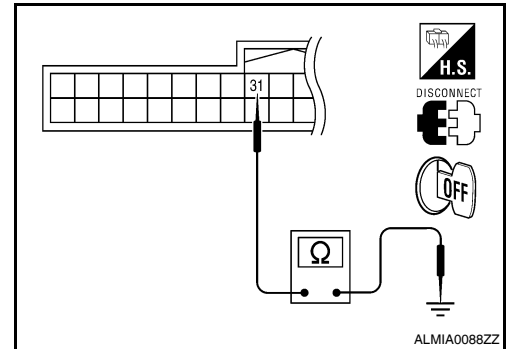

### 3. CHECK INTERMITTENT INCIDENT

Refer to [GI-39. "Intermittent Incident"](#).

>> Inspection End.



# B260A IGNITION RELAY

< COMPONENT DIAGNOSIS >

[POWER DISTRIBUTION SYSTEM]

## B260A IGNITION RELAY

### Description

INFOID:000000005460625

BCM turns ON the following relays to ignition power supply to each ECU when the ignition switch is turned ON.

- Ignition relay-1 (inside IPDM E/R)
- Ignition relay-2 (inside fuse box)
- Front blower motor relay

BCM checks any ignition relay ON request for consistency with the actual ignition relay operation status.

### DTC Logic

INFOID:000000005460626

### DTC DETECTION LOGIC

#### NOTE:

- If DTC B260A is displayed with DTC U1000, first perform the trouble diagnosis for DTC U1000. Refer to [PCS-53, "DTC Logic"](#).
- If DTC B260A is displayed with DTC U1010, first perform the trouble diagnosis for DTC U1010. Refer to [PCS-54, "DTC Logic"](#).
- If DTC B260A is displayed with DTC B261A, first perform the trouble diagnosis for DTC B261A. Refer to [PCS-69, "DTC Logic"](#).

DTC No.	Trouble diagnosis name	DTC detecting condition	Possible cause
B260A	IGNITION RELAY	BCM detects a difference of signal for 2 seconds or more between the following information. <ul style="list-style-type: none"><li>• Ignition relay-1 (ON/OFF) operation</li><li>• Ignition relay-1 feedback</li></ul>	<ul style="list-style-type: none"><li>• Harness or connectors (Ignition relay-1 operation circuit is open or shorted.)</li></ul>

### DTC CONFIRMATION PROCEDURE

#### 1. PERFORM DTC CONFIRMATION PROCEDURE

1. Turn ignition switch ON under the following conditions, and wait for at least 2 seconds.
  - CVT selector lever is in the P or N position.
  - Release the brake pedal.
2. Check "Self diagnostic result" with CONSULT-III.

#### Is DTC detected?

- YES >> Go to [PCS-57, "Diagnosis Procedure"](#).  
NO >> Inspection End.

### Diagnosis Procedure

INFOID:000000005460627

Regarding Wiring Diagram information, refer to [PCS-123, "Wiring Diagram"](#).

#### 1. CHECK DATA MONITOR

1. Turn ignition switch ON.
2. Check IGN RLY1-REQ and IGN RLY status with CONSULT-III. Refer to [PCS-16, "CONSULT - III Function \(IPDM E/R\)"](#).

#### Do IGN RLY1-REQ and IGN RLY signals change as expected?

- YES >> Refer to [GI-39, "Intermittent Incident"](#).  
NO >> IGN RLY1-REQ does not change. GO TO 2.  
NO >> IGN RLY does not change. GO TO 3.

#### 2. CHECK CAN COMMUNICATION

Check CAN communication. Refer to [LAN-25, "CAN System Specification Chart"](#).

#### Is the inspection result normal?

- YES >> Replace BCM. Refer to [BCS-87, "Removal and Installation"](#).

A

B

C

D

E

F

G

H

I

J

K

L

PCS

N

O

P

# B260A IGNITION RELAY

[POWER DISTRIBUTION SYSTEM]

## < COMPONENT DIAGNOSIS >

NO >> Repair harness of connector.

### 3. CHECK IGNITION RELAY SIGNAL

1. Turn ignition switch OFF.
2. Check voltage between IPDM E/R harness connector and ground.

(+)		(-)	Voltage
IPDM E/R			
Connector	Terminal	Ground	Battery voltage
E18	27		

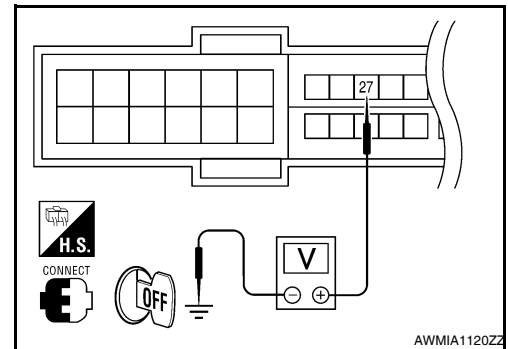

3. Turn ignition switch ON.
4. Check voltage between IPDM E/R harness connector and ground.

(+)		(-)	Voltage
IPDM E/R			
Connector	Terminal	Ground	0 V
E18	27		

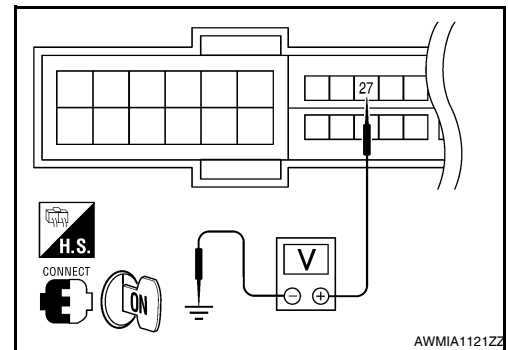

Are the inspection results normal?

YES >> Replace IPDM E/R. Refer to [PCS-41, "Removal and Installation"](#).

NO >> Repair harness of connector.

# B2614 ACC RELAY CIRCUIT

< COMPONENT DIAGNOSIS >

[POWER DISTRIBUTION SYSTEM]

## B2614 ACC RELAY CIRCUIT

### Description

INFOID:000000005460628

BCM controls the various electrical components and simultaneously supplies power according to the power supply position.  
BCM checks the power supply position internally.

### DTC Logic

INFOID:000000005460629

### DTC DETECTION LOGIC

DTC No.	Trouble diagnosis name	DTC detecting condition	Possible cause
B2614	ACC relay circuit	An immediate operation of ACC relay is requested by BCM, but there is no response for more than 1 second.	<ul style="list-style-type: none"> <li>Harness or connectors (ACC relay circuit is open or shorted)</li> <li>ACC relay</li> </ul>

### DTC CONFIRMATION PROCEDURE

#### 1. PERFORM DTC CONFIRMATION PROCEDURE

- Turn the power supply position to ACC under the following conditions, and wait for at least 1 second.
  - CVT selector lever is in the P or N position.
  - Release the brake pedal.
- Check "Self diagnostic result" with CONSULT-III.

#### Is DTC detected?

- YES >> Go to [PCS-59, "Diagnosis Procedure"](#).  
NO >> Inspection End.

### Diagnosis Procedure

INFOID:000000005460630

Regarding Wiring Diagram information, refer to [PCS-123, "Wiring Diagram"](#).

#### 1. CHECK ACCESSORY RELAY POWER SUPPLY

- Turn ignition switch OFF.
- Disconnect accessory relay.
- Check voltage between accessory relay harness connector and ground under the following conditions.

Accessory relay Terminal	Ground	Condition		Voltage (V)
		Ignition		
2	Ground	OFF		0
		ACC		Battery voltage

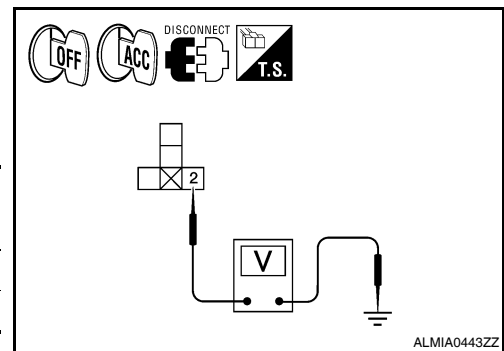

#### Is the inspection result normal?

- YES >> GO TO 3  
NO >> GO TO 2

#### 2. CHECK ACCESSORY RELAY POWER SUPPLY CIRCUIT

## B2614 ACC RELAY CIRCUIT

### < COMPONENT DIAGNOSIS >

### [POWER DISTRIBUTION SYSTEM]

1. Turn ignition switch OFF.
2. Disconnect BCM harness connector.
3. Check continuity between accessory relay harness connector (A) and BCM harness connector (B).

Accessory relay	BCM		Continuity
Terminal	Connector	Terminal	
2	M18	83	Yes

4. Check continuity between accessory relay harness connector and ground.

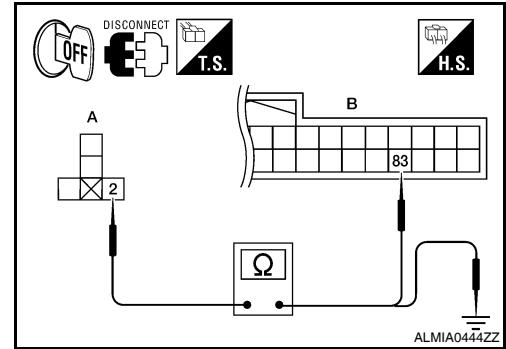

Accessory relay	Ground	Continuity
Terminal		
2	Ground	No

#### Is the inspection result normal?

- YES >> GO TO 6  
 NO >> Repair or replace harness.

### 3. CHECK ACCESSORY RELAY GROUND CIRCUIT

1. Turn ignition switch OFF.
2. Check continuity between accessory relay harness connector and ground.

Accessory relay	Ground	Continuity
Terminal		
1	Ground	Yes

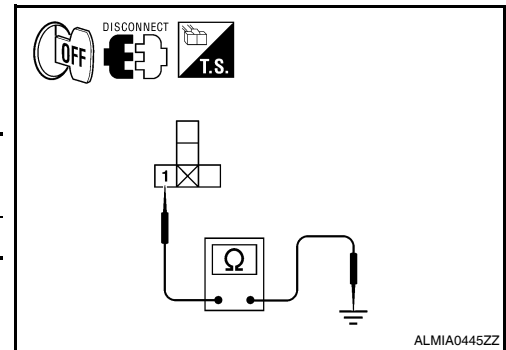

#### Is the inspection result normal?

- YES >> GO TO 4  
 NO >> Repair or replace harness.

### 4. CHECK ACCESSORY RELAY POWER SUPPLY CIRCUIT-2

Check voltage between accessory relay harness connector and ground.

Accessory relay	Ground	Voltage (V)
Terminal		
3	Ground	Battery voltage

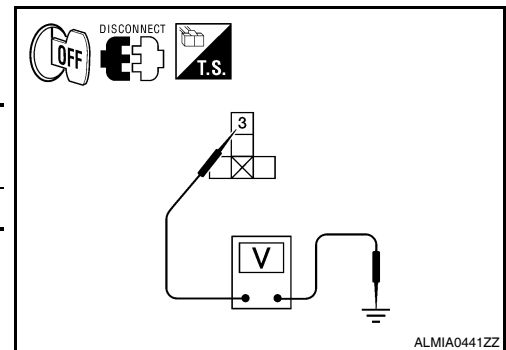

#### Is the inspection result normal?

- YES >> GO TO 5  
 NO >> Repair or replace harness.

### 5. CHECK ACCESSORY RELAY

Refer to [PCS-61, "Component Inspection \(Accessory Relay\)"](#).

#### YES or NO

- YES >> GO TO 6  
 NO >> Replace accessory relay.

### 6. CHECK INTERMITTENT INCIDENT

Refer to [GI-39, "Intermittent Incident"](#).

>> Inspection End.

# B2614 ACC RELAY CIRCUIT

< COMPONENT DIAGNOSIS >

[POWER DISTRIBUTION SYSTEM]

## Component Inspection (Accessory Relay)

INFOID:000000005460631

### 1. CHECK ACCESSORY RELAY

1. Turn ignition switch OFF.
2. Remove accessory relay.
3. Check the continuity between accessory relay terminals under the following conditions.

Terminals	Condition	Continuity
3 and 5	12V direct current supply between terminals 1 and 2	Yes
	No current supply	No

Is the inspection result normal?

- YES >> Inspection End.  
NO >> Replace accessory relay.

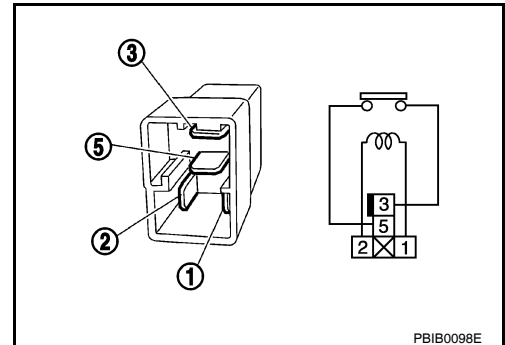

PBIB0098E

A  
B  
C  
D  
E  
F  
G  
H  
I  
J  
K  
L  
N  
O  
P

PCS

# B2615 FRONT BLOWER MOTOR RELAY CIRCUIT

< COMPONENT DIAGNOSIS >

[POWER DISTRIBUTION SYSTEM]

## B2615 FRONT BLOWER MOTOR RELAY CIRCUIT

### Description

INFOID:000000005460632

BCM controls the various electrical components and simultaneously supplies power according to the power supply position.

BCM checks the power supply position internally.

### DTC Logic

INFOID:000000005460633

### DTC DETECTION LOGIC

DTC No.	Trouble diagnosis name	DTC detecting condition	Possible cause
B2615	Front blower motor relay circuit	BCM detects a difference of signal for 1 second or more between the following information. <ul style="list-style-type: none"><li>• Front blower motor relay ON/OFF request</li><li>• Front blower motor relay feedback</li></ul>	<ul style="list-style-type: none"><li>• Harness or connectors (Front blower motor relay circuit is open or shorted)</li><li>• Front blower motor relay</li></ul>

### DTC CONFIRMATION PROCEDURE

#### 1. PERFORM DTC CONFIRMATION PROCEDURE

1. Turn ignition switch ON under the following conditions, and wait for at least 1 second.
  - CVT selector lever is in the P or N position.
  - Release brake pedal.
2. Check "Self diagnostic result" with CONSULT-III.

#### Is DTC detected?

- YES >> Go to [PCS-62, "Diagnosis Procedure"](#).  
NO >> Inspection End.

### Diagnosis Procedure

INFOID:000000005460634

Regarding Wiring Diagram information, refer to [PCS-123, "Wiring Diagram"](#).

#### 1. CHECK FRONT BLOWER MOTOR RELAY POWER SUPPLY

1. Turn ignition switch OFF.
2. Disconnect front blower motor relay.
3. Check voltage between front blower motor relay harness connector and ground under the following conditions.

Front blower motor relay Terminal	Ground	Condition	Voltage (V)
2	Ground	OFF or ACC	0
		ON	Battery voltage

#### Is the inspection result normal?

- YES >> GO TO 3  
NO >> GO TO 2

#### 2. CHECK FRONT BLOWER MOTOR RELAY POWER SUPPLY CIRCUIT

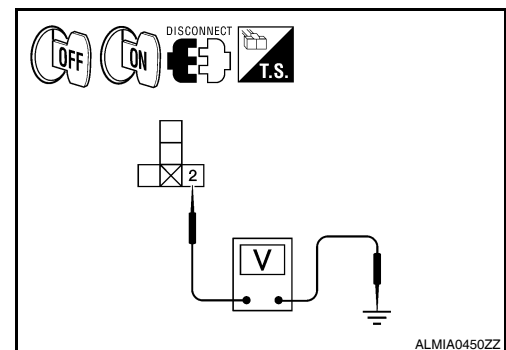

# B2615 FRONT BLOWER MOTOR RELAY CIRCUIT

[POWER DISTRIBUTION SYSTEM]

## < COMPONENT DIAGNOSIS >

1. Turn ignition switch OFF.
2. Disconnect BCM harness connector.
3. Check continuity between front blower motor relay harness connector (A) and BCM harness connector (B).

Front blower motor relay	BCM		Continuity
Terminal	Connector	Terminal	
2	M19	90	Yes

4. Check continuity between front blower motor relay harness connector (A) and ground.

Front blower motor relay	Ground	Continuity
Terminal		
2	Ground	No

Is the inspection result normal?

- YES >> GO TO 6  
 NO >> Repair or replace harness.

### 3. CHECK FRONT BLOWER MOTOR RELAY GROUND CIRCUIT

1. Turn ignition switch OFF.
2. Check continuity between front blower motor relay harness connector and ground.

Front blower motor relay	Ground	Continuity
Terminal		
1	Ground	Yes

Is the inspection result normal?

- YES >> GO TO 4  
 NO >> Repair front blower motor relay ground circuit.

### 4. CHECK FRONT BLOWER MOTOR RELAY POWER SUPPLY CIRCUIT-2

Check voltage between front blower motor relay harness connector and ground.

Front blower motor relay	Ground	Voltage (V)
Terminal		
3	Ground	Battery voltage

Is the inspection result normal?

- YES >> GO TO 5  
 NO >> Repair or replace harness.

### 5. CHECK FRONT BLOWER MOTOR RELAY

Refer to [PCS-64, "Component Inspection \(Front Blower Motor Relay\)"](#).

Is the inspection result normal?

- YES >> GO TO 6  
 NO >> Replace front blower motor relay.

### 6. CHECK INTERMITTENT INCIDENT

Refer to [GI-39, "Intermittent Incident"](#).

>> Inspection End.

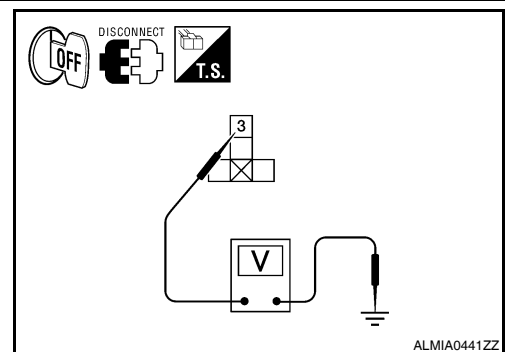
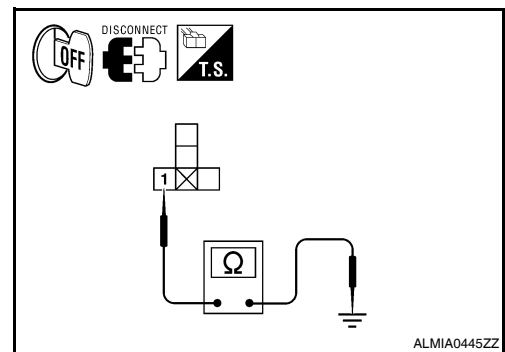
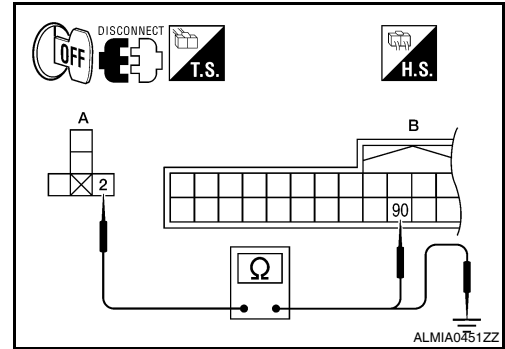

A  
B  
C  
D  
E  
F  
G  
H  
I  
J  
K  
L  
N  
O  
P

PCS

# B2615 FRONT BLOWER MOTOR RELAY CIRCUIT

< COMPONENT DIAGNOSIS >

[POWER DISTRIBUTION SYSTEM]

## Component Inspection (Front Blower Motor Relay)

INFOID:000000005460635

### 1. CHECK FRONT BLOWER MOTOR RELAY

1. Turn ignition switch OFF.
2. Remove front blower motor relay.
3. Check the continuity between front blower motor relay terminals under the following conditions.

Terminals	Condition	Continuity
3 and 5	12V direct current supply between terminals 1 and 2	Yes
	No current supply	No

Is the inspection result normal?

- YES >> Inspection End.  
NO >> Replace front blower motor relay.

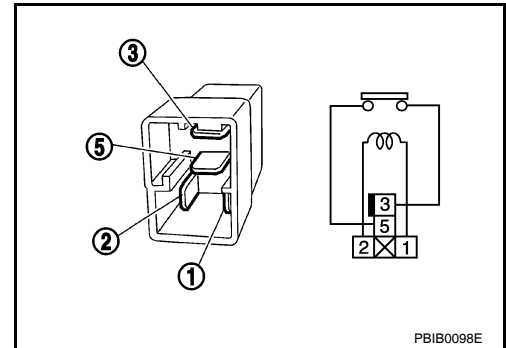



# B2616 IGNITION RELAY CIRCUIT

< COMPONENT DIAGNOSIS >

[POWER DISTRIBUTION SYSTEM]

## B2616 IGNITION RELAY CIRCUIT

### Description

INFOID:000000005460636

BCM controls the various electrical components and simultaneously supplies power according to the power supply position.  
BCM checks the power supply position internally.

### DTC Logic

INFOID:000000005460637

### DTC DETECTION LOGIC

DTC No.	Trouble diagnosis name	DTC detecting condition	Possible cause
B2616	Ignition relay circuit	An immediate operation of ignition relay (fuse block) is requested by BCM, but there is no response for more than 1 second	<ul style="list-style-type: none"> <li>Harness or connectors (Ignition relay circuit is open or shorted)</li> <li>Ignition relay (Fuse block)</li> </ul>

### DTC CONFIRMATION PROCEDURE

#### 1. PERFORM DTC CONFIRMATION PROCEDURE

- Turn ignition switch ON under the following conditions, and wait for at least 1 second.
  - CVT selector lever is in the P or N position
  - Release brake pedal
- Check "Self diagnostic result" with CONSULT-III.

#### Is DTC detected?

- YES >> Go to [PCS-65, "Diagnosis Procedure"](#).  
NO >> Inspection End.

### Diagnosis Procedure

INFOID:000000005460638

Regarding Wiring Diagram information, refer to [PCS-123, "Wiring Diagram"](#).

#### 1. CHECK IGNITION RELAY POWER SUPPLY

- Turn ignition switch OFF.
- Disconnect ignition relay.
- Check voltage between ignition relay harness connector and ground under the following conditions.

Ignition relay Terminal	Ground	Condition	Voltage (V)	
		1	Ground	Ignition switch OFF or ACC
			Ignition switch ON	Battery voltage

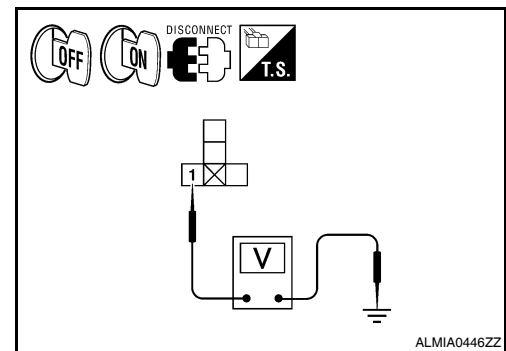

#### Is the inspection result normal?

- YES >> GO TO 3  
NO >> GO TO 2

#### 2. CHECK IGNITION RELAY POWER SUPPLY CIRCUIT

## B2616 IGNITION RELAY CIRCUIT

[POWER DISTRIBUTION SYSTEM]

### < COMPONENT DIAGNOSIS >

1. Turn ignition switch OFF.
2. Disconnect BCM harness connector.
3. Check continuity between ignition relay harness connector (A) and BCM harness connector (B).

Ignition relay	BCM		Continuity
Terminal	Connector	Terminal	
1	M19	70	Yes

4. Check continuity between ignition relay harness connector (A) and ground.

Ignition relay	Ground	Continuity
Terminal		
1	Ground	No

Is the inspection result normal?

- YES >> GO TO 6  
 NO >> Repair or replace harness.

### 3. CHECK IGNITION RELAY GROUND CIRCUIT

1. Turn ignition switch OFF.
2. Check continuity between ignition relay harness connector and ground.

Ignition relay	Ground	Continuity
Terminal		
2	Ground	Yes

Is the inspection result normal?

- YES >> GO TO 4  
 NO >> Repair or replace harness.

### 4. CHECK IGNITION RELAY POWER SUPPLY CIRCUIT-2

Check voltage between ignition relay harness connector and ground.

Ignition relay	Ground	Voltage (V)
Terminal		
5	Ground	Battery voltage

Is the inspection result normal?

- YES >> GO TO 5  
 NO >> Repair or replace harness.

### 5. CHECK IGNITION RELAY

Refer to [PCS-67, "Component Inspection \(Ignition Relay\)"](#).

Is the inspection result normal?

- YES >> GO TO 6  
 NO >> Replace ignition relay.

### 6. CHECK INTERMITTENT INCIDENT

Refer to [GI-39, "Intermittent Incident"](#).

>> Inspection End.

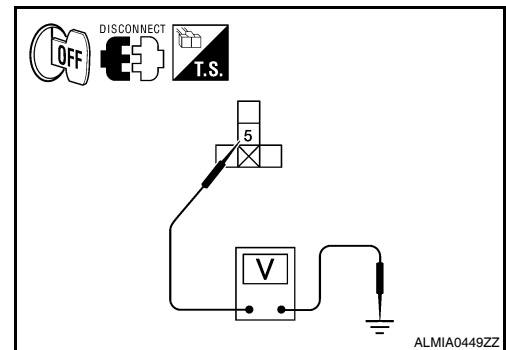
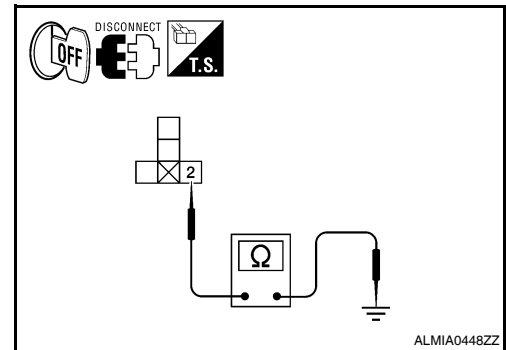
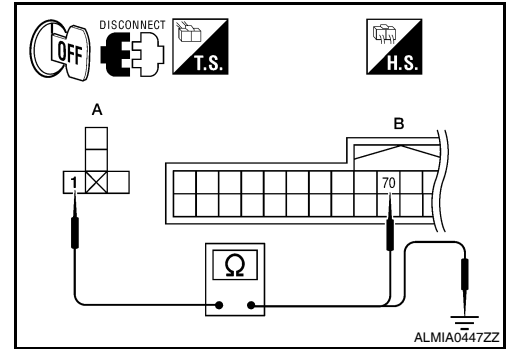

# B2616 IGNITION RELAY CIRCUIT

< COMPONENT DIAGNOSIS >

[POWER DISTRIBUTION SYSTEM]

## Component Inspection (Ignition Relay)

INFOID:000000005460639

### 1. CHECK IGNITION RELAY

1. Turn ignition switch OFF.
2. Remove ignition relay.
3. Check the continuity between ignition relay terminals under the following conditions.

Terminals	Condition	Continuity
3 and 5	12V direct current supply between terminals 1 and 2	Yes
	No current supply	No

Is the inspection result normal?

- YES >> Inspection End.  
NO >> Replace ignition relay.

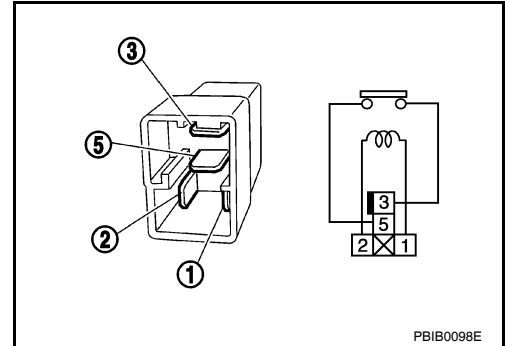

A  
B  
C  
D  
E  
F  
G  
H  
I  
J  
K  
L  
N  
O  
P

PCS

B2618 BCM

Description

INFOID:000000005460640

BCM controls the various electrical components and simultaneously supplies power according to the power supply position.  
 BCM checks the power supply position internally.

DTC Logic

INFOID:000000005460641

DTC DETECTION LOGIC

**NOTE:**

- If DTC B2618 is displayed with DTC U1000, first perform the trouble diagnosis for DTC U1000. Refer to [PCS-53, "DTC Logic"](#).
- If DTC B2618 is displayed with DTC U1010, first perform the trouble diagnosis for DTC U1010. Refer to [PCS-54, "DTC Logic"](#).

DTC No.	Trouble diagnosis name	DTC detecting condition	Possible cause
B2618	BCM	An immediate operation of ignition relay (IPDM E/R) is requested by BCM, but there is no response for more than 1 second	• BCM

DTC CONFIRMATION PROCEDURE

**1. PERFORM DTC CONFIRMATION PROCEDURE**

1. Turn ignition switch ON under the following conditions, and wait for at least 1 second.
  - CVT selector lever is in the P or N position
  - Release brake pedal
2. Check "Self diagnostic result" with CONSULT-III.

Is DTC detected?

- YES >> Go to [PCS-68, "Diagnosis Procedure"](#).  
 NO >> Inspection End.

Diagnosis Procedure

INFOID:000000005460642

**1. INSPECTION START**

1. Turn ignition switch ON.
2. Select "Self diagnostic result" mode with CONSULT-III.
3. Touch "ERASE".
4. **Perform DTC Confirmation Procedure.**  
 See [PCS-68, "DTC Logic"](#).

Is the 1st trip DTC B2618 displayed again?

- YES >> Replace BCM. Refer to [BCS-87, "Removal and Installation"](#).  
 NO >> Inspection End.

# B261A PUSH-BUTTON IGNITION SWITCH

< COMPONENT DIAGNOSIS >

[POWER DISTRIBUTION SYSTEM]

## B261A PUSH-BUTTON IGNITION SWITCH

### Description

INFOID:000000005460643

BCM transmits the change in the power supply position with the push-button ignition switch to IPDM E/R via the CAN communication line. IPDM E/R transmits the power supply position status via CAN communication line to BCM.

### DTC Logic

INFOID:000000005460644

### DTC DETECTION LOGIC

DTC No.	Trouble diagnosis name	DTC detecting condition	Possible cause
B261A	PUSH-BUTTON IGNITION SWITCH	BCM detects a difference of signal for 1 second or more between the following information. <ul style="list-style-type: none"><li>Power supply position by push-button ignition switch</li><li>Power supply position from IPDM E/R (CAN)</li></ul>	<ul style="list-style-type: none"><li>Harness or connectors (Push-button ignition switch circuit is open or shorted.)</li></ul>

### DTC CONFIRMATION PROCEDURE

#### 1. PERFORM DTC CONFIRMATION PROCEDURE

- Press the push-button ignition switch under the following conditions, and wait for at least 1 second.
  - CVT selector lever is in the P or N position.
  - Release the brake pedal.
- Check "Self diagnostic result" with CONSULT-III.

#### Is DTC detected?

- YES >> Go to [PCS-69, "Diagnosis Procedure"](#).  
NO >> Inspection End.

### Diagnosis Procedure

INFOID:000000005460645

Regarding Wiring Diagram information, refer to [PCS-123, "Wiring Diagram"](#).

#### 1. CHECK PUSH-BUTTON IGNITION SWITCH OPERATION

Press push-button ignition switch and check if it turns to ON.

#### Does ignition switch turn to ON?

- YES >> GO TO 2  
NO >> GO TO 4

#### 2. CHECK IGNITION SWITCH OUTPUT SIGNAL (IPDM E/R)

- Turn ignition switch OFF.
- Disconnect push-button ignition switch.
- Check voltage between IPDM E/R harness connector and ground.

Terminals		Voltage (V)
(+)	(-)	
IPDM E/R		Ground
Connector	Terminal	
E18	28	
		Battery voltage

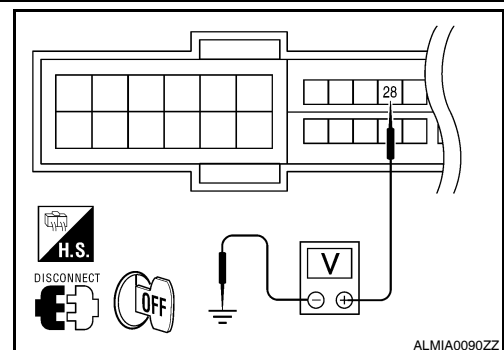

#### Is the inspection result normal?

- YES >> GO TO 3  
NO >> Replace IPDM E/R. Refer to [PCS-41, "Removal and Installation"](#).

# B261A PUSH-BUTTON IGNITION SWITCH

[POWER DISTRIBUTION SYSTEM]

< COMPONENT DIAGNOSIS >

## 3. CHECK PUSH-BUTTON IGNITION SWITCH CIRCUIT (IPDM E/R)

1. Disconnect IPDM E/R and BCM.
2. Check continuity between IPDM E/R harness connector (A) and push-button ignition switch harness connector (B).

IPDM E/R		Push-button ignition switch		Continuity
Connector	Terminal	Connector	Terminal	
E18 (A)	28	M38 (B)	4	Yes

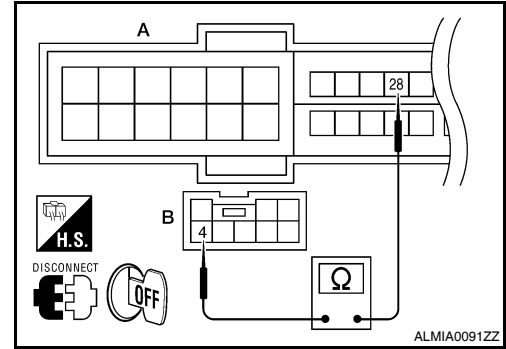

3. Check continuity between IPDM E/R harness connector and ground.

IPDM E/R		Ground	Continuity
Connector	Terminal		
E18	28		No

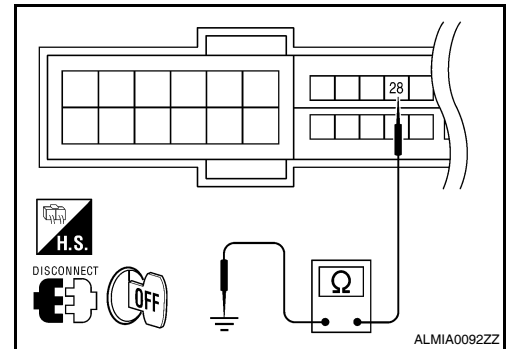

Is the inspection result normal?

- YES >> GO TO 6  
 NO >> Repair or replace harness.

## 4. CHECK IGNITION SWITCH OUTPUT SIGNAL (BCM)

1. Disconnect push-button ignition switch.
2. Check voltage between BCM harness connector and ground.

Terminals		Voltage (V)
(+)	(-)	
BCM		Ground
Connector	Terminal	
M19 (A) (with electronic steering column lock)	77	
M21 (B) (without electronic steering column lock)	140	Battery voltage

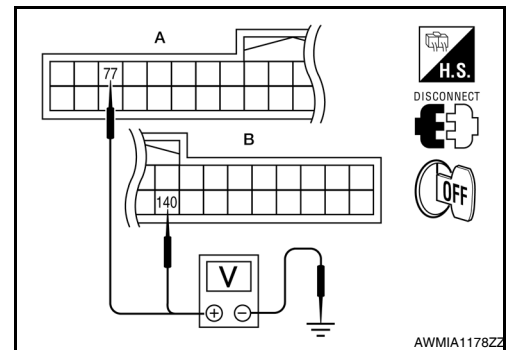

Is the inspection result normal?

- YES >> GO TO 5  
 NO >> Replace BCM. Refer to [BCS-87, "Removal and Installation"](#).

## 5. CHECK PUSH-BUTTON IGNITION SWITCH CIRCUIT (BCM)

1. Disconnect BCM and IPDM E/R.
2. Check continuity between BCM harness connector and push-button ignition switch harness connector.

BCM		Push-button ignition switch		Continuity
Connector	Terminal	Connector	Terminal	
M19 (A) (with electronic steering column lock)	77	M38 (C)	4	Yes
M21 (B) (without electronic steering column lock)	140			

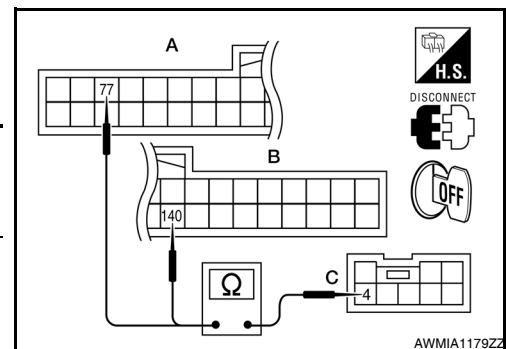

# B261A PUSH-BUTTON IGNITION SWITCH

[POWER DISTRIBUTION SYSTEM]

< COMPONENT DIAGNOSIS >

3. Check continuity between BCM harness connector and ground.

BCM		Terminal	Continuity
Connector			
M19 (A) (with electronic steering column lock)	77	Ground	No
M21 (B) (without electronic steering column lock)	140		

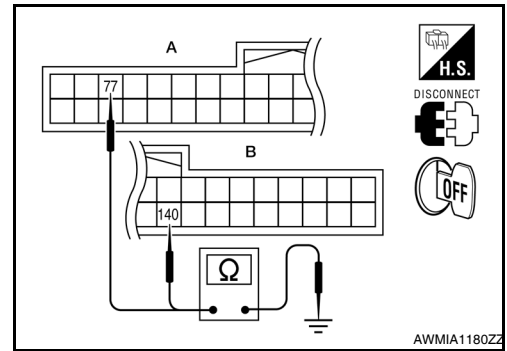

Is the inspection result normal?

YES >> GO TO 6

NO >> Repair or replace harness.

**6. CHECK INTERMITTENT INCIDENT**

Refer to [GI-39. "Intermittent Incident"](#).

>> Inspection End.

A  
B  
C  
D  
E  
F  
G  
H  
I  
J  
K  
L  
N  
O  
P

PCS

# POWER SUPPLY AND GROUND CIRCUIT

< COMPONENT DIAGNOSIS >

[POWER DISTRIBUTION SYSTEM]

## POWER SUPPLY AND GROUND CIRCUIT

### BCM

#### BCM : Diagnosis Procedure

INFOID:000000005511878

Regarding Wiring Diagram information, refer to [PCS-101. "Wiring Diagram"](#).

### 1. CHECK FUSE AND FUSIBLE LINK

Check if the following BCM fuses or fusible link are blown.

Terminal No.	Signal name	Fuse and fusible link No.
1	Battery power supply	H
11		10
24		7

Is the fuse or fusible link blown?

- YES >> Replace the blown fuse or fusible link after repairing the affected circuit.  
NO >> GO TO 2

### 2. CHECK POWER SUPPLY CIRCUIT

1. Turn ignition switch OFF.
2. Disconnect BCM.
3. Check voltage between BCM harness connector and ground.

Terminals		Voltage (Approx.)
(+)	(-)	
BCM		Ground  Battery voltage
Connector	Terminal	
M16 (A)	1	
M17 (B)	11	
M18 (C)	24	

Is the measurement normal?

- YES >> GO TO 3  
NO >> Repair or replace harness.

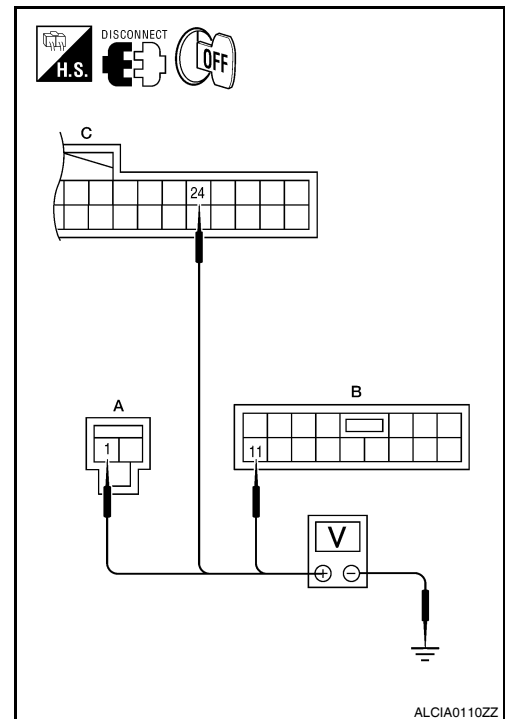

### 3. CHECK GROUND CIRCUIT



# POWER SUPPLY AND GROUND CIRCUIT

< COMPONENT DIAGNOSIS >

[POWER DISTRIBUTION SYSTEM]

Check continuity between BCM harness connector and ground.

BCM		Ground	Continuity
Connector	Terminal		
M17	13		Yes

Does continuity exist?

- YES >> Inspection End.
- NO >> Repair or replace harness.

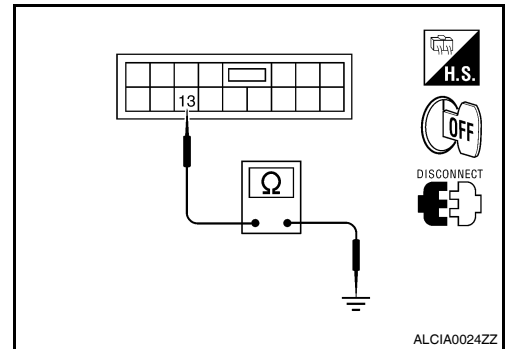

## IPDM E/R (INTELLIGENT POWER DISTRIBUTION MODULE ENGINE ROOM)

### IPDM E/R (INTELLIGENT POWER DISTRIBUTION MODULE ENGINE ROOM) : Diagnosis Procedure

INFOID:000000005511879

Regarding Wiring Diagram information, refer to [PCS-31. "Wiring Diagram"](#).

### 1. CHECK FUSES AND FUSIBLE LINK

Check that the following IPDM E/R fuses or fusible link are not blown.

Terminal No.	Signal name	Fuses and fusible link No.
1, 2	Battery power supply	B, D
—		42
—		43

Is the fuse blown?

- YES >> Replace the blown fuse or fusible link after repairing the affected circuit.
- NO >> GO TO 2

### 2. CHECK POWER SUPPLY CIRCUIT

1. Turn ignition switch OFF.
2. Disconnect IPDM E/R connectors.
3. Check voltage between IPDM E/R harness connector and ground.

Terminals		Voltage (V) (Approx.)
(+)	(-)	
IPDM E/R		Battery voltage
Connector	Terminal	
E16	1	
	2	

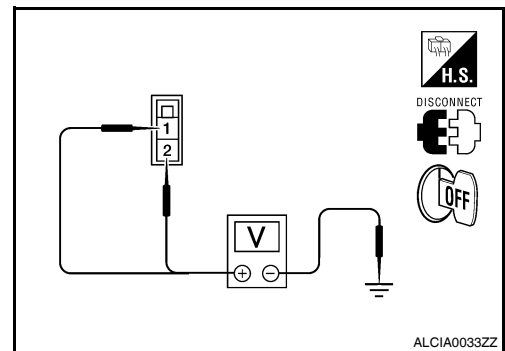

Is the measurement value normal?

- YES >> GO TO 3
- NO >> Repair harness or connector.

### 3. CHECK GROUND CIRCUIT

A  
B  
C  
D  
E  
F  
G  
H  
I  
J  
K  
L  
PCS  
N  
O  
P

# POWER SUPPLY AND GROUND CIRCUIT

## [POWER DISTRIBUTION SYSTEM]

### < COMPONENT DIAGNOSIS >

Check continuity between IPDM E/R harness connectors and ground.

IPDM E/R		Ground	Continuity
Connector	Terminal		
A: E18	12		Yes
B: E17	41		

Does continuity exist?

YES >> Inspection End.

NO >> Repair harness or connector.

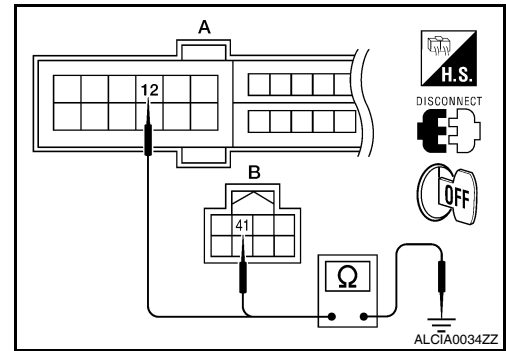

# PUSH-BUTTON IGNITION SWITCH POSITION INDICATOR

< COMPONENT DIAGNOSIS >

[POWER DISTRIBUTION SYSTEM]

## PUSH-BUTTON IGNITION SWITCH POSITION INDICATOR

### Description

INFOID:000000005460648

The switch that changes the power supply position.  
BCM maintains the power supply position status.  
BCM changes the power supply position with the operation of the push-button ignition switch.

### Component Function Check

INFOID:000000005460649

#### 1. CHECK FUNCTION

##### With CONSULT-III

1. Check push-button ignition switch ("LOCK INDICATOR", "ACC INDICATOR" and "IGNITION ON IND") in Active Test Mode with CONSULT-III.

Test item		Description	
LOCK INDICATOR	ON	Position indicator	: Illuminate
ACC INDICATOR IGNITION ON IND	OFF		: Not illuminate

Is the inspection result normal?

- YES >> Inspection End.  
NO >> Refer to [PCS-75, "Diagnosis Procedure"](#).

### Diagnosis Procedure

INFOID:000000005460650

Regarding Wiring Diagram information, refer to [PCS-123, "Wiring Diagram"](#).

#### 1. CHECK PUSH-BUTTON IGNITION SWITCH INPUT SIGNAL

1. Turn ignition switch OFF.
2. Disconnect push-button ignition switch.
3. Check voltage between push-button ignition switch harness connector and ground.

Terminals		Voltage (V)
(+)	(-)	
Push-button ignition switch		Ground
Connector	Terminal	
M38	8	
		Battery voltage

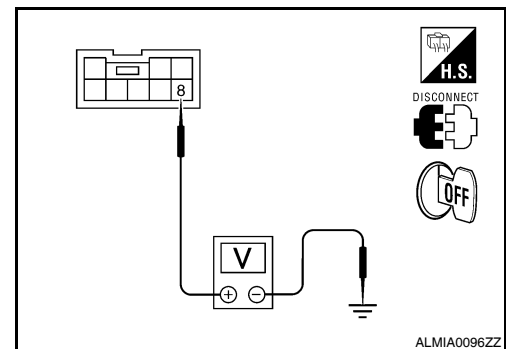

Is the inspection result normal?

- YES >> GO TO 2  
NO >> Check the following.
- 10A fuse [No. 9, located in fuse block (J/B)]
  - Harness for open or short between push-button ignition switch and fuse.

#### 2. CHECK PUSH-BUTTON IGNITION SWITCH CIRCUIT

# PUSH-BUTTON IGNITION SWITCH POSITION INDICATOR

## [POWER DISTRIBUTION SYSTEM]

### < COMPONENT DIAGNOSIS >

1. Disconnect BCM and push-button ignition switch.
2. Check continuity between BCM harness connector and push-button ignition switch harness connector.

Indicator	BCM Connector	Terminal	Push-button ignition switch connector	Terminal	Continuity
LOCK	M18 (A)	42	M38 (D)	5	Yes
ACC	M17 (B)	15		6	
ON	M19 (C)	81		7	

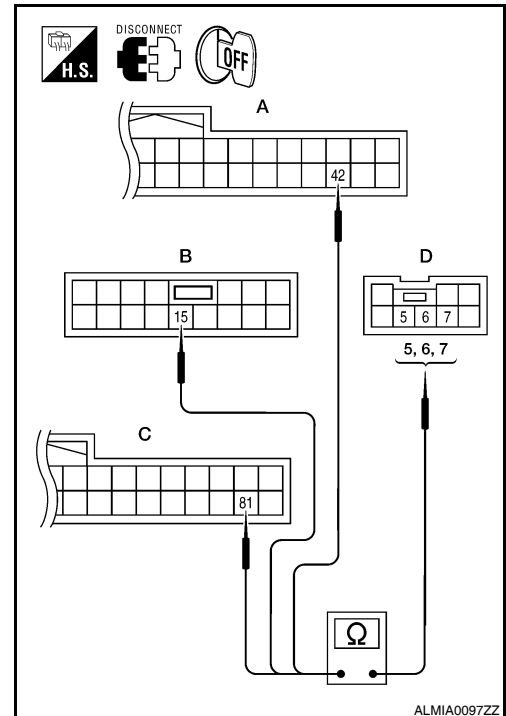

3. Check continuity between BCM harness connector and ground.

Indicator	BCM connector	Terminal	Ground	Continuity
LOCK	M18 (A)	42		No
ACC	M17 (B)	15		
ON	M19 (C)	81		

Is the inspection result normal?

- YES >> GO TO 3  
 NO >> Repair or replace harness.

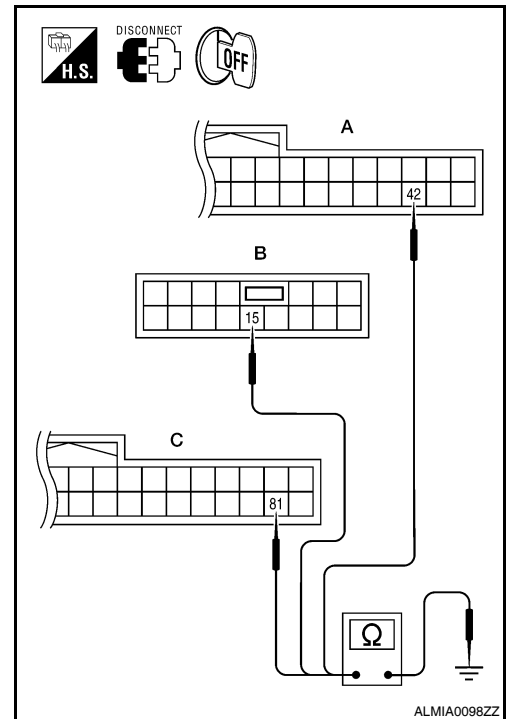

### 3. CHECK PUSH-BUTTON IGNITION SWITCH

Refer to [PCS-77. "Component Inspection"](#).

Is the inspection result normal?

- YES >> GO TO 4  
 NO >> Replace push-button ignition switch. Refer to [SEC-197. "Removal and Installation"](#).

### 4. CHECK INTERMITTENT INCIDENT

Refer to [GI-39. "Intermittent Incident"](#).

>> Inspection End.

# PUSH-BUTTON IGNITION SWITCH POSITION INDICATOR

< COMPONENT DIAGNOSIS >

[POWER DISTRIBUTION SYSTEM]

## Component Inspection

INFOID:000000005460651

### 1. CHECK PUSH-BUTTON IGNITION SWITCH

Check push-button ignition switch.

Terminal		Push-button ignition switch position	Continuity
Push-button ignition switch			
8	5	LOCK	Yes
	6	ACC	
	7	ON	

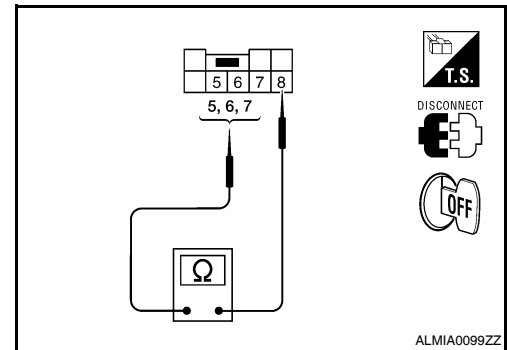

Is the inspection result normal?

YES >> Inspection End.

NO >> Replace push-button ignition switch. Refer to [SEC-197, "Removal and Installation"](#).

A  
B  
C  
D  
E  
F  
G  
H  
I  
J  
K  
L

PCS

N  
O  
P

# BCM (BODY CONTROL MODULE)

< ECU DIAGNOSIS >

[POWER DISTRIBUTION SYSTEM]

## ECU DIAGNOSIS

### BCM (BODY CONTROL MODULE)

Reference Value

INFOID:000000005511880

#### VALUES ON THE DIAGNOSIS TOOL

Monitor Item	Condition	Value/Status
FR WIPER HI	Other than front wiper switch HI	OFF
	Front wiper switch HI	ON
FR WIPER LOW	Other than front wiper switch LO	OFF
	Front wiper switch LO	ON
FR WASHER SW	Front washer switch OFF	OFF
	Front washer switch ON	ON
FR WIPER INT	Other than front wiper switch INT	OFF
	Front wiper switch INT	ON
FR WIPER STOP	Front wiper is not in STOP position	OFF
	Front wiper is in STOP position	ON
INT VOLUME	Wiper intermittent dial is in a dial position 1 - 7	Wiper intermittent dial position
TURN SIGNAL R	Other than turn signal switch RH	OFF
	Turn signal switch RH	ON
TURN SIGNAL L	Other than turn signal switch LH	OFF
	Turn signal switch LH	ON
TAIL LAMP SW	Other than lighting switch 1ST and 2ND	OFF
	Lighting switch 1ST or 2ND	ON
HI BEAM SW	Other than lighting switch HI	OFF
	Lighting switch HI	ON
HEAD LAMP SW 1	Other than lighting switch 2ND	OFF
	Lighting switch 2ND	ON
HEAD LAMP SW 2	Other than lighting switch 2ND	OFF
	Lighting switch 2ND	ON
PASSING SW	Other than lighting switch PASS	OFF
	Lighting switch PASS	ON
AUTO LIGHT SW	Other than lighting switch AUTO	OFF
	Lighting switch AUTO	ON
FR FOG SW	Front fog lamp switch OFF	OFF
	Front fog lamp switch ON	ON
DOOR SW-DR	Driver door closed	OFF
	Driver door opened	ON
DOOR SW-AS	Passenger door closed	OFF
	Passenger door opened	ON
DOOR SW-RR	Rear door RH closed	OFF
	Rear door RH opened	ON
DOOR SW-RL	Rear door LH closed	OFF
	Rear door LH opened	ON

# BCM (BODY CONTROL MODULE)

< ECU DIAGNOSIS >

[POWER DISTRIBUTION SYSTEM]

Monitor Item	Condition	Value/Status
CDL LOCK SW	Other than power door lock switch LOCK	OFF
	Power door lock switch LOCK	ON
CDL UNLOCK SW	Other than power door lock switch UNLOCK	OFF
	Power door lock switch UNLOCK	ON
KEY CYL LK-SW	Other than driver door key cylinder LOCK position	OFF
	Driver door key cylinder LOCK position	ON
KEY CYL UN-SW	Other than driver door key cylinder UNLOCK position	OFF
	Driver door key cylinder UNLOCK position	ON
HAZARD SW	When hazard switch is not pressed	OFF
	When hazard switch is pressed	ON
REAR DEF SW	When rear window defogger switch is pressed	ON
TR CANCEL SW	Trunk lid opener cancel switch OFF	OFF
	Trunk lid opener cancel switch ON	ON
TR/BD OPEN SW	Trunk lid opener switch OFF	OFF
	While the trunk lid opener switch is turned ON	ON
TRNK/HAT MNTR	Trunk lid closed	OFF
	Trunk lid opened	ON
RKE-LOCK	When LOCK button of Intelligent Key is not pressed	OFF
	When LOCK button of Intelligent Key is pressed	ON
RKE-UNLOCK	When UNLOCK button of Intelligent Key is not pressed	OFF
	When UNLOCK button of Intelligent Key is pressed	ON
RKE-TR/BD	When TRUNK OPEN button of Intelligent Key is not pressed	OFF
	When TRUNK OPEN button of Intelligent Key is pressed	ON
RKE-PANIC	When PANIC button of Intelligent Key is not pressed	OFF
	When PANIC button of Intelligent Key is pressed	ON
RKE-P/W OPEN	When UNLOCK button of Intelligent Key is not pressed and held	OFF
	When UNLOCK button of Intelligent Key is pressed and held	ON
RKE-MODE CHG	When LOCK/UNLOCK button of Intelligent Key is not pressed and held simultaneously	OFF
	When LOCK/UNLOCK button of Intelligent Key is pressed and held simultaneously	ON
OPTICAL SENSOR	When outside of the vehicle is bright	Close to 5 V
	When outside of the vehicle is dark	Close to 0 V
REQ SW-DR	When front door request switch is not pressed (driver side)	OFF
	When front door request switch is pressed (driver side)	ON
REQ SW-AS	When front door request switch is not pressed (passenger side)	OFF
	When front door request switch is pressed (passenger side)	ON
REQ SW-RL	When rear door request switch is not pressed (driver side)	OFF
	When rear door request switch is pressed (driver side)	ON
REQ SW-RR	When rear door request switch is not pressed (passenger side)	OFF
	When rear door request switch is pressed (passenger side)	ON
REQ SW-BD/TR	When trunk request switch is not pressed	OFF
	When trunk request switch is pressed	ON
PUSH SW	When engine switch (push switch) is not pressed	OFF
	When engine switch (push switch) is pressed	ON

A  
B  
C  
D  
E  
F  
G  
H  
I  
J  
K  
L  
PCS  
N  
O  
P

# BCM (BODY CONTROL MODULE)

< ECU DIAGNOSIS >

[POWER DISTRIBUTION SYSTEM]

Monitor Item	Condition	Value/Status
IGN RLY 2-F/B	Ignition switch OFF or ACC	OFF
	Ignition switch ON	ON
ACC RLY-F/B	Ignition switch OFF	OFF
	Ignition switch ACC or ON	ON
BRAKE SW 1	When the brake pedal is not depressed	ON
	When the brake pedal is depressed	OFF
DETE/CANCL SW	When selector lever is in P position	OFF
	When selector lever is in any position other than P	ON
SFT PN/N SW	When selector lever is in any position other than P or N	OFF
	When selector lever is in P or N position	ON
S/L-LOCK*	Electronic steering column lock LOCK status	OFF
	Electronic steering column lock UNLOCK status	ON
S/L-UNLOCK*	Electronic steering column lock UNLOCK status	OFF
	Electronic steering column lock LOCK status	ON
S/L RELAY-F/B*	Ignition switch OFF or ACC	OFF
	Ignition switch ON	ON
UNLK SEN-DR	Driver door UNLOCK status	OFF
	Driver door LOCK status	ON
PUSH SW-IPDM	When engine switch (push switch) is not pressed	OFF
	When engine switch (push switch) is pressed	ON
IGN RLY1 F/B	Ignition switch OFF or ACC	OFF
	Ignition switch ON	ON
DETE SW -IPDM	When selector lever is in P position	OFF
	When selector lever is in any position other than P	ON
SFT PN -IPDM	When selector lever is in any position other than P or N	OFF
	When selector lever is in P or N position	ON
SFT P-MET	When selector lever is in any position other than P	OFF
	When selector lever is in P position	ON
SFT N-MET	When selector lever is in any position other than N	OFF
	When selector lever is in N position	ON
ENGINE STATE	Engine stopped	STOP
	While the engine stalls	STALL
	At engine cranking	CRANK
	Engine running	RUN
S/L LOCK-IPDM*	Electronic steering column lock LOCK status	OFF
	Electronic steering column lock UNLOCK status	ON
S/L UNLK-IPDM*	Electronic steering column lock UNLOCK status	OFF
	Electronic steering column lock LOCK status	ON
S/L RELAY-REQ*	Ignition switch OFF or ACC	OFF
	Ignition switch ON	ON
VEH SPEED 1	While driving	Equivalent to speedometer reading
VEH SPEED 2	While driving	Equivalent to speedometer reading



# BCM (BODY CONTROL MODULE)

< ECU DIAGNOSIS >

[POWER DISTRIBUTION SYSTEM]

Monitor Item	Condition	Value/Status	
DOOR STAT-DR	Driver door LOCK status	LOCK	A
	Wait with selective UNLOCK operation (5 seconds)	READY	
	Driver door UNLOCK status	UNLK	B
DOOR STAT-AS	Passenger door LOCK status	LOCK	
	Wait with selective UNLOCK operation (5 seconds)	READY	C
	Passenger door UNLOCK status	UNLK	
ID OK FLAG	Ignition switch ACC or ON	RESET	
	Ignition switch OFF	SET	D
PRMT ENG STRT	When the engine start is prohibited	RESET	
	When the engine start is permitted	SET	
KEY SW -SLOT	When Intelligent Key is not inserted into key slot	OFF	E
	When Intelligent Key is inserted into key slot	ON	
RKE OPE COUN1	During the operation of Intelligent Key	Operation frequency of Intelligent Key	F
CONFRM ID ALL	The key ID that the key slot receives does not accord with any key ID registered to BCM.	YET	
	The key ID that the key slot receives accords with any key ID registered to BCM.	DONE	G
CONFIRM ID4	The key ID that the key slot receives does not accord with the fourth key ID registered to BCM.	YET	
	The key ID that the key slot receives accords with the fourth key ID registered to BCM.	DONE	H
CONFIRM ID3	The key ID that the key slot receives does not accord with the third key ID registered to BCM.	YET	I
	The key ID that the key slot receives accords with the third key ID registered to BCM.	DONE	
CONFIRM ID2	The key ID that the key slot receives does not accord with the second key ID registered to BCM.	YET	J
	The key ID that the key slot receives accords with the second key ID registered to BCM.	DONE	K
CONFIRM ID1	The key ID that the key slot receives does not accord with the first key ID registered to BCM.	YET	
	The key ID that the key slot receives accords with the first key ID registered to BCM.	DONE	L
TP 4	The ID of fourth key is not registered to BCM	YET	PCS
	The ID of fourth key is registered to BCM	DONE	
TP 3	The ID of third key is not registered to BCM	YET	
	The ID of third key is registered to BCM	DONE	N
TP 2	The ID of second key is not registered to BCM	YET	
	The ID of second key is registered to BCM	DONE	
TP 1	The ID of first key is not registered to BCM	YET	O
	The ID of first key is registered to BCM	DONE	
AIR PRESS FL	Ignition switch ON (only when the signal from the transmitter is received)	Air pressure of front LH tire	P
AIR PRESS FR	Ignition switch ON (only when the signal from the transmitter is received)	Air pressure of front RH tire	
AIR PRESS RR	Ignition switch ON (only when the signal from the transmitter is received)	Air pressure of rear RH tire	
AIR PRESS RL	Ignition switch ON (only when the signal from the transmitter is received)	Air pressure of rear LH tire	

# BCM (BODY CONTROL MODULE)

< ECU DIAGNOSIS >

[POWER DISTRIBUTION SYSTEM]

Monitor Item	Condition	Value/Status
ID REGST FL1	When ID of front LH tire transmitter is registered	DONE
	When ID of front LH tire transmitter is not registered	YET
ID REGST FR1	When ID of front RH tire transmitter is registered	DONE
	When ID of front RH tire transmitter is not registered	YET
ID REGST RR1	When ID of rear RH tire transmitter is registered	DONE
	When ID of rear RH tire transmitter is not registered	YET
ID REGST RL1	When ID of rear LH tire transmitter is registered	DONE
	When ID of rear LH tire transmitter is not registered	YET
WARNING LAMP	Tire pressure indicator OFF	OFF
	Tire pressure indicator ON	ON
BUZZER	Tire pressure warning alarm is not sounding	OFF
	Tire pressure warning alarm is sounding	ON

\* : With electronic steering column lock

# BCM (BODY CONTROL MODULE)

[POWER DISTRIBUTION SYSTEM]

< ECU DIAGNOSIS >

## Terminal Layout

INFOID:000000005511881

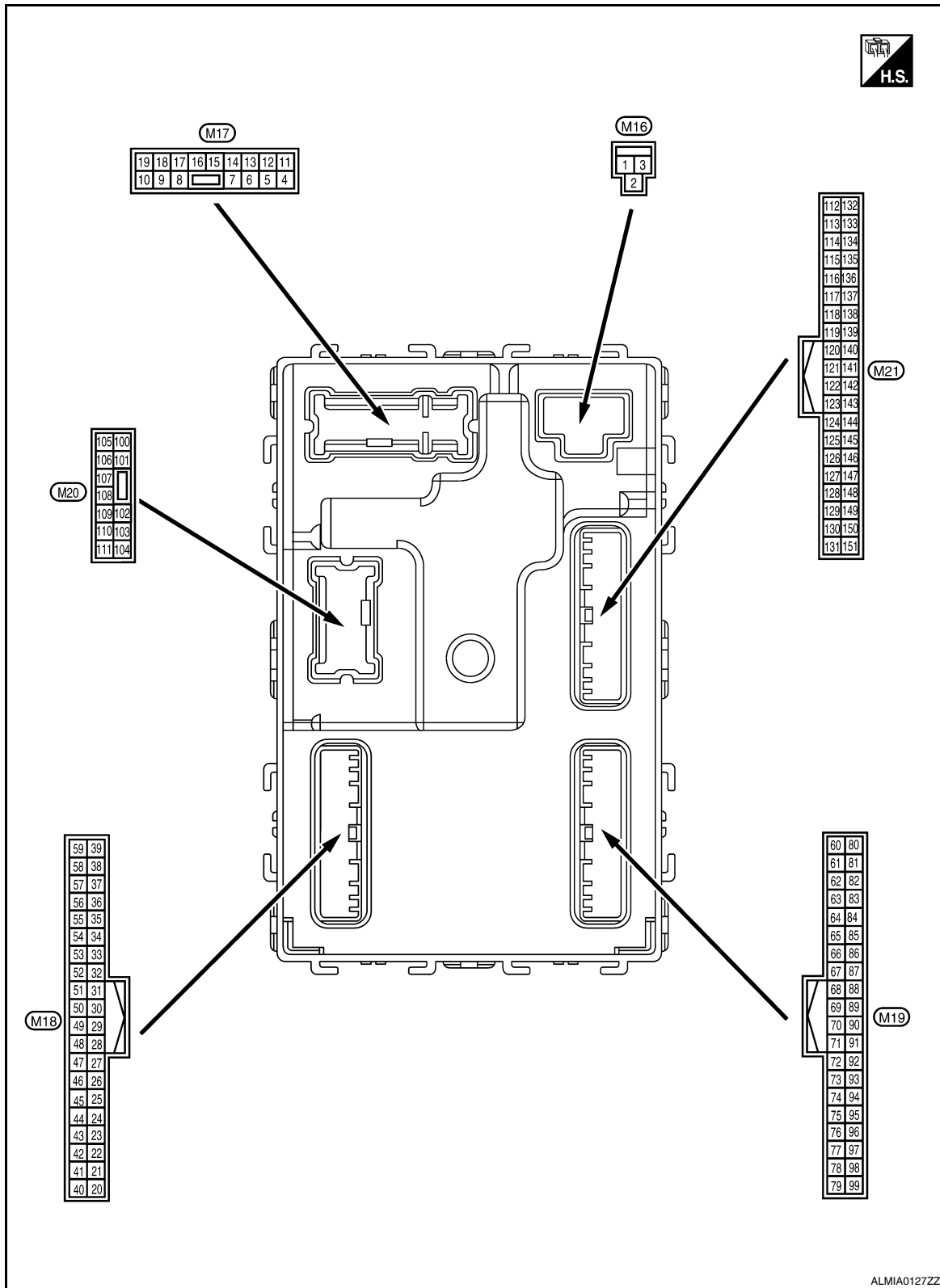

## Physical Values

INFOID:000000005511882

# BCM (BODY CONTROL MODULE)

< ECU DIAGNOSIS >

[POWER DISTRIBUTION SYSTEM]

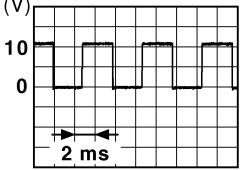
Terminal No. (Wire color)		Description		Condition		Value (Approx.)
		Signal name	Input/ Output			
(+)	(-)					
1 (W/B)	Ground	Battery power supply	Input	Ignition switch OFF		Battery voltage
2 (R/Y)	Ground	Battery power supply output	Output	Ignition switch OFF		Battery voltage
3 (L/W)	Ground	Ignition power supply output	Output	Ignition switch ON		Battery voltage
4 (P/W)	Ground	Interior room lamp power supply	Output	After passing the interior room lamp battery saver operation time		0V
				Any other time after passing the interior room lamp battery saver operation time		Battery voltage
5 (G)	Ground	Front door RH UNLOCK	Output	Front door RH	UNLOCK (actuator is activated)	Battery voltage
					Other than UNLOCK (actuator is not activated)	0V
7 (R/W)	Ground	Step lamp	Output	Step lamp	ON	0V
					OFF	Battery voltage
8 (V)	Ground	All doors LOCK	Output	All doors	LOCK (actuator is activated)	Battery voltage
					Other than LOCK (actuator is not activated)	0V
9 (L)	Ground	Front door LH UNLOCK	Output	Front door LH	UNLOCK (actuator is activated)	Battery voltage
					Other than UNLOCK (actuator is not activated)	0V
10 (G)	Ground	Rear door RH and rear door LH UNLOCK	Output	Rear door RH and rear door LH	UNLOCK (actuator is activated)	Battery voltage
					Other than UNLOCK (actuator is not activated)	0V
11 (Y/R)	Ground	Battery power supply	Input	Ignition switch OFF		Battery voltage
13 (B)	Ground	Ground	—	Ignition switch ON		0V
14 (GR/W)	Ground	Engine switch (push switch) illumination ground	Input	Tail lamp	OFF	0V
					ON	<b>NOTE:</b> When the illumination brightening/dimming level is in the neutral position 
15 (Y/L)	Ground	ACC indicator lamp	Output	Ignition switch	OFF	Battery voltage
					ACC or ON	0V

JSNIA0010GB

# BCM (BODY CONTROL MODULE)

## [POWER DISTRIBUTION SYSTEM]

< ECU DIAGNOSIS >

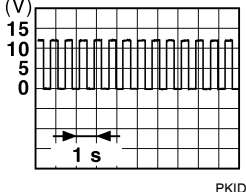
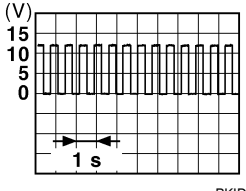
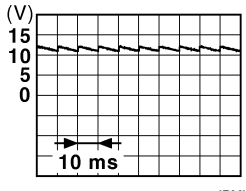
Terminal No. (Wire color)		Description		Condition	Value (Approx.)
(+)	(-)	Signal name	Input/ Output		
17 (G/B)	Ground	Turn signal (RH)	Output	Ignition switch ON	Turn signal switch OFF 0V
				Turn signal switch RH	 <p style="text-align: center;">6.5 V</p>
18 (G/Y)	Ground	Turn signal (LH)	Output	Ignition switch ON	Turn signal switch OFF 0V
				Turn signal switch LH	 <p style="text-align: center;">6.5 V</p>
19 (Y)	Ground	Room lamp timer control	Output	Interior room lamp	OFF Battery voltage
				ON	0V
21 (P/B)	Ground	Optical sensor signal	Input	Ignition switch ON	When outside of the vehi- cle is bright Close to 5V
				When outside of the vehi- cle is dark Close to 0V	
24 (R/W)	Ground	Stop lamp switch 1	Input	—	Battery voltage
26 (O/L)	Ground	Stop lamp switch 2	Input	Stop lamp switch	OFF (brake pedal is re- leased) 0V
				ON (brake pedal is de- pressed) Battery voltage	
27 (O)	Ground	Front door lock as- sembly LH (unlock sensor)	Input	Front door LH	LOCK status  <p style="text-align: center;">11.8V</p>
				UNLOCK status 0V	
29 (Y)	Ground	Key slot switch	Input	When Intelligent Key is inserted into key slot Battery voltage	
				When Intelligent Key is not inserted into key slot 0V	
30 (V/Y)	Ground	ACC feedback signal	Input	Ignition switch	OFF 0
				ACC or ON Battery voltage	
31 (G)	Ground	Rear window defog- ger feedback signal	Input	Rear window de- fogger switch	OFF 0V
				ON Battery voltage	



A  
B  
C  
D  
E  
F  
G  
H  
I  
J  
K  
L  
N  
O  
P

PCS

# BCM (BODY CONTROL MODULE)

< ECU DIAGNOSIS >

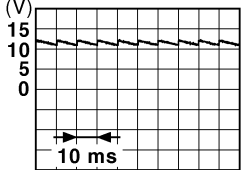
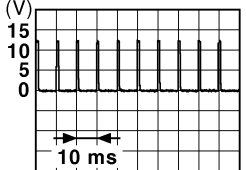
[POWER DISTRIBUTION SYSTEM]

Terminal No. (Wire color)		Description		Condition		Value (Approx.)
(+)	(-)	Signal name	Input/ Output			
32 (R/B)	Ground	Front door RH switch	Input	Front door RH switch	OFF (when front door RH closes)	 <small>JPMIA0011GB</small> 11.8 V
					ON (when front door RH opens)	0V
37 (O)	Ground	Trunk lid opener cancel switch	Input	Trunk lid opener cancel switch	CANCEL	 <small>JPMIA0012GB</small> 1.1V
					ON	0V
38 (GR/W)	Ground	Rear window defogger ON signal	Input	Rear window defogger switch	OFF	5V
					ON	0V
40 (Y/G)	Ground	Power window serial link	Input/ Output	Ignition switch ON	Ignition switch ON	 <small>JPMIA0013GB</small> 10.2V
					Ignition switch OFF or ACC	0V
41 (W)	Ground	Engine switch (push switch) illumination	Output	Engine switch (push switch) illumination	ON	5.5V
					OFF	0V
42 (R)	Ground	LOCK indicator lamp	Output	LOCK indicator lamp	ON	0V
					OFF	Battery voltage
45 (P)	Ground	Receiver & sensor ground	Input	Ignition switch ON		0V
46 (V/W)	Ground	Receiver & sensor power supply output	Output	Ignition switch	OFF	0V
					ACC or ON	5.0V

# BCM (BODY CONTROL MODULE)

## [POWER DISTRIBUTION SYSTEM]

### < ECU DIAGNOSIS >

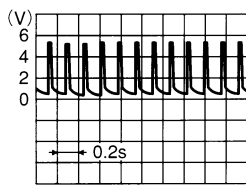
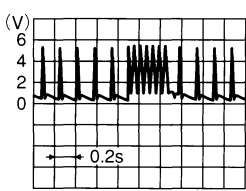
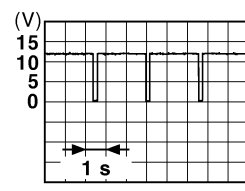
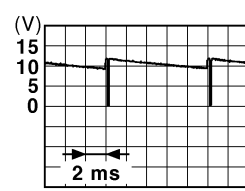
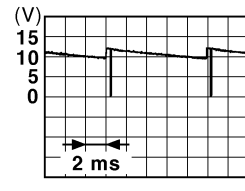
Terminal No. (Wire color)		Description		Condition	Value (Approx.)
(+)	(-)	Signal name	Input/ Output		
47 <sup>1</sup> (G/O)	Ground	Tire pressure receiver signal	Input/ Output	Ignition switch ON	Standby state 
				When receiving the signal from the transmitter 	
48 (R/G)	Ground	Selector lever transmission range switch signal	Input	Selector lever	P or N position 12.0V
				Except P and N positions	0V
49 (L/O)	Ground	Security indicator signal	Output	Security indicator	ON 0V
				Blinking 	11.3V
50 (LG/B)	Ground	Combination switch OUTPUT 5	Output	Combination switch (Wiper intermittent dial 4)	All switch OFF 0V
				Lighting switch 1ST	Turn signal switch RH 
				Lighting switch high-beam	
				Lighting switch 2ND	
51 (L/W)	Ground	Combination switch OUTPUT 1	Output	Combination switch	All switch OFF (Wiper intermittent dial 4) 0V
				Any of the conditions below with all switch OFF • Wiper intermittent dial 1 • Wiper intermittent dial 2 • Wiper intermittent dial 3 • Wiper intermittent dial 6 • Wiper intermittent dial 7 	10.7V

A  
B  
C  
D  
E  
F  
G  
H  
I  
J  
K  
L  
N  
O  
P

PCS

# BCM (BODY CONTROL MODULE)

## [POWER DISTRIBUTION SYSTEM]

< ECU DIAGNOSIS >

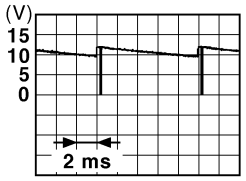
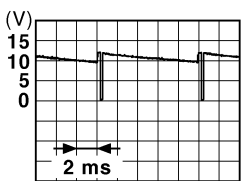
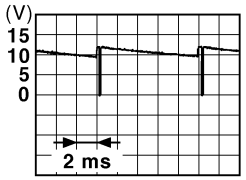
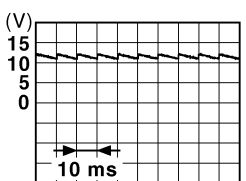
Terminal No. (Wire color)		Description		Condition		Value (Approx.)
(+)	(-)	Signal name	Input/ Output			
52 (G/B)	Ground	Combination switch OUTPUT 2	Output	Combination switch	All switch OFF (Wiper intermittent dial 4)	0V
					Front washer switch ON (Wiper intermittent dial 4)	 <p style="text-align: right; font-size: small;">JPMIA0033GB</p>
					Any of the conditions below with all switch OFF <ul style="list-style-type: none"> <li>• Wiper intermittent dial 1</li> <li>• Wiper intermittent dial 5</li> <li>• Wiper intermittent dial 6</li> </ul>	
53 (LG/ R)	Ground	Combination switch OUTPUT 3	Output	Combination switch (Wiper intermit- tent dial 4)	All switch OFF	0V
					Front wiper switch INT	 <p style="text-align: right; font-size: small;">JPMIA0034GB</p>
					Front wiper switch LO	
					Lighting switch AUTO	
54 (G/Y)	Ground	Combination switch OUTPUT 4	Output	Combination switch (Wiper intermit- tent dial 4)	All switch OFF	0V
					Front fog lamp switch ON	 <p style="text-align: right; font-size: small;">JPMIA0035GB</p>
					Lighting switch 2ND	
					Lighting switch flash-to- pass	
					Turn signal switch LH	
57 <sup>1</sup> (W)	Ground	Tire pressure warn- ing check switch	Input	—	—	5V
58 (SB)	Ground	Front door LH switch	Input	Front door LH switch	OFF (front door LH CLOSE)	 <p style="text-align: right; font-size: small;">JPMIA0011GB</p>
					ON (front door LH OPEN)	
59 (G/R)	Ground	Rear window defog- ger relay	Output	Rear window de- fogger	Active	Battery voltage
					Not activated	0V



# BCM (BODY CONTROL MODULE)

## [POWER DISTRIBUTION SYSTEM]

### < ECU DIAGNOSIS >

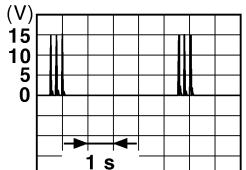
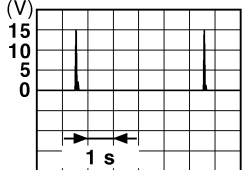
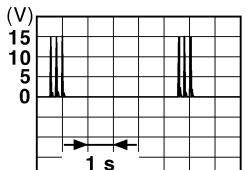
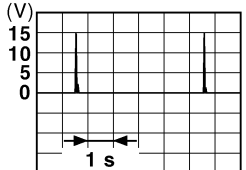
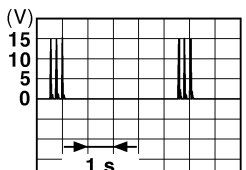
Terminal No. (Wire color)		Description		Condition	Value (Approx.)
(+)	(-)	Signal name	Input/ Output		
60 (B/R)	Ground	Front console antenna 2 (-)	Output		
				When Intelligent Key is not in the passenger compartment	 <p style="text-align: right; font-size: small;">JMKIA0063GB</p>
61 (W/R)	Ground	Center console antenna 2 (+)	Output	Ignition switch OFF	 <p style="text-align: right; font-size: small;">JMKIA0062GB</p>
				When Intelligent Key is not in the passenger compartment	 <p style="text-align: right; font-size: small;">JMKIA0063GB</p>
62 (V)	Ground	Front outside handle RH antenna (-)	Output	When the front door RH request switch is operated with ignition switch OFF	 <p style="text-align: right; font-size: small;">JMKIA0062GB</p>
				When Intelligent Key is not in the antenna detection area	 <p style="text-align: right; font-size: small;">JMKIA0063GB</p>

A  
B  
C  
D  
E  
F  
G  
H  
I  
J  
K  
L  
N  
O  
P

PCS

# BCM (BODY CONTROL MODULE)

## [POWER DISTRIBUTION SYSTEM]

### < ECU DIAGNOSIS >

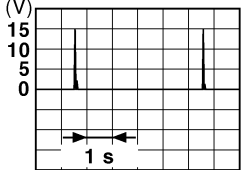
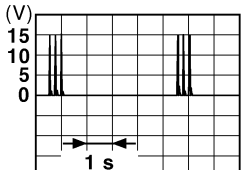
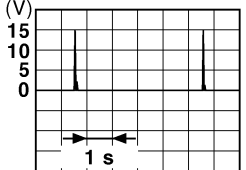
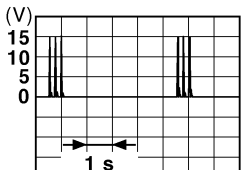
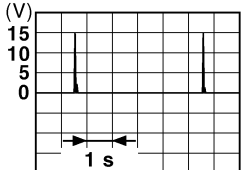
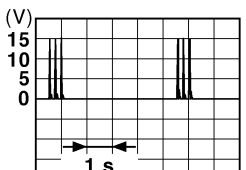
Terminal No. (Wire color)		Description		Condition	Value (Approx.)
(+)	(-)	Signal name	Input/ Output		
63 (P)	Ground	Front outside handle RH antenna (+)	Output	When the front door RH request switch is operat- ed with ignition switch OFF	When Intelligent Key is in the antenna detection area  
				When Intelligent Key is not in the antenna detection area  	
64 (V)	Ground	Front outside handle LH antenna (-)	Output	When the front door LH request switch is operat- ed with ignition switch OFF	When Intelligent Key is in the antenna detection area  
				When Intelligent Key is not in the antenna detection area  	
65 (P)	Ground	Front outside handle LH antenna (+)	Output	When the front door LH request switch is operat- ed with ignition switch OFF	When Intelligent Key is in the antenna detection area  
				When Intelligent Key is not in the antenna detection area  	

JMKIA0062GB

JMKIA0063GB

JMKIA0062GB

JMKIA0063GB

JMKIA0062GB

JMKIA0063GB

# BCM (BODY CONTROL MODULE)

## [POWER DISTRIBUTION SYSTEM]

< ECU DIAGNOSIS >

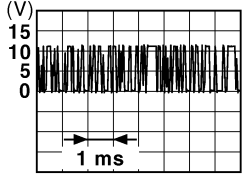
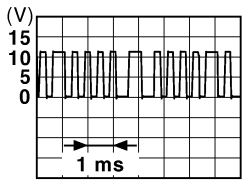
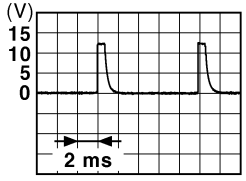
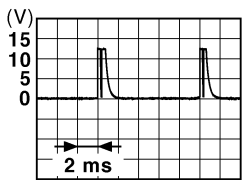
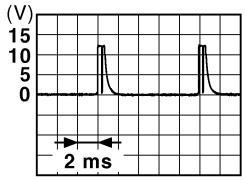

Terminal No. (Wire color)		Description		Condition		Value (Approx.)
(+)	(-)	Signal name	Input/ Output			
68 (G/O)	Ground	NATS antenna amp (built in key slot)	Input/ Output	During waiting	Ignition switch is pressed while inserting the Intelli- gent Key into the key slot.	Just after pressing ignition switch. Pointer of tester should move.
69 (O)	Ground	NATS antenna amp (built in key slot)	Input/ Output	During waiting	Ignition switch is pressed while inserting the Intelli- gent Key into the key slot.	Just after pressing ignition switch. Pointer of tester should move.
70 (R/B)	Ground	Ignition relay-2 con- trol	Output	Ignition switch	OFF or ACC	0V
					ON	Battery voltage
71 (L/O)	Ground	Remote keyless entry receiver signal	Input/ Output	During waiting		 <small>JMKIA0064GB</small>
				When operating either button on Intelligent Key		 <small>JMKIA0065GB</small>
75 (R/Y)	Ground	Combination switch INPUT 5	Input	Combination switch	All switch OFF (Wiper intermittent dial 4)	 <small>JPMIA0041GB</small> 1.4V
					Front fog lamp switch ON (Wiper intermittent dial 4)	 <small>JPMIA0037GB</small> 1.3V
					Any of the conditions below with all switch OFF • Wiper intermittent dial 1 • Wiper intermittent dial 2 • Wiper intermittent dial 6 • Wiper intermittent dial 7	 <small>JPMIA0040GB</small> 1.3V

A  
B  
C  
D  
E  
F  
G  
H  
I  
J  
K  
L  
PCS  
N  
O  
P

# BCM (BODY CONTROL MODULE)

## [POWER DISTRIBUTION SYSTEM]

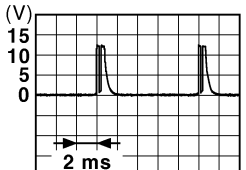
< ECU DIAGNOSIS >

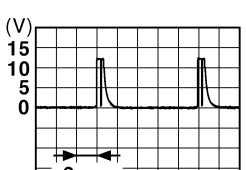
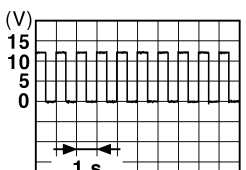
Terminal No. (Wire color)		Description		Condition	Value (Approx.)	
(+)	(-)	Signal name	Input/ Output			
76 (R/G)	Ground	Combination switch INPUT 3	Input			Combination switch
				Lighting switch high-beam (Wiper intermittent dial 4)	 <small>JPMIA0036GB</small> 1.3V	
				Lighting switch 2ND (Wiper intermittent dial 4)	 <small>JPMIA0037GB</small> 1.3V	
				Any of the conditions below with all switch OFF • Wiper intermittent dial 1 • Wiper intermittent dial 2 • Wiper intermittent dial 3	 <small>JPMIA0040GB</small> 1.3V	
77 <sup>2</sup> (BR)	Ground	Engine switch (push switch)	Input	Engine switch (push switch)	Pressed	0V
					Not pressed	Battery voltage
78 (P)	Ground	CAN-L	Input/ Output	—	—	
79 (L)	Ground	CAN-H	Input/ Output	—	—	
80 (R/L)	Ground	Key slot illumination	Output	Key slot illumina- tion	OFF	0V
					Blinking	 <small>JPMIA0015GB</small> 6.5V
					ON	Battery voltage

# BCM (BODY CONTROL MODULE)

< ECU DIAGNOSIS >

[POWER DISTRIBUTION SYSTEM]

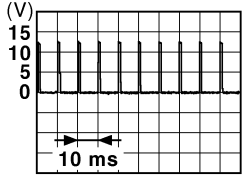
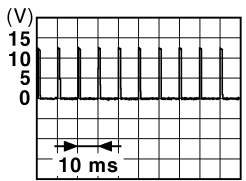
Terminal No. (Wire color)		Description		Condition		Value (Approx.)
		Signal name	Input/ Output			
(+)	(-)					
81 (LG)	Ground	ON indicator lamp	Output	Ignition switch	OFF or ACC	0V
					ON	Battery voltage
83 (L)	Ground	ACC relay control	Output	Ignition switch	OFF	0V
					ACC or ON	Battery voltage
84 (Y/R)	Ground	CVT shift selector	Output	—		Battery voltage
85 <sup>3</sup> (L/O)	Ground	Electronic steering column lock condition No. 1	Input	Electronic steering column lock	Lock status	0V
					Unlock status	Battery voltage
86 <sup>3</sup> (G/R)	Ground	Electronic steering column lock condition No. 2	Input	Electronic steering column lock	Lock status	Battery voltage
					Unlock status	0V
87 (G/B)	Ground	Selector lever P position switch	Input	Selector lever	P position	0V
					Any position other than P	Battery voltage
88 (R)	Ground	Front door RH request switch	Input	Front door RH request switch	ON (pressed)	0V
					OFF (not pressed)	 <p style="text-align: center;">1.0V</p>
89 (R)	Ground	Front door LH request switch	Input	Front door LH request switch	ON (pressed)	0V
					OFF (not pressed)	 <p style="text-align: center;">1.0V</p>
90 (Y)	Ground	Blower fan motor relay control	Output	Ignition switch	OFF or ACC	0V
					ON	Battery voltage
91 (L/R)	Ground	Remote keyless entry receiver power supply	Output	Ignition switch OFF		Battery voltage
94 <sup>3</sup> (G/Y)	Ground	Steering wheel lock unit power supply	Output	Ignition switch	OFF or ACC	Battery voltage
					ON	0V

A  
B  
C  
D  
E  
F  
G  
H  
I  
J  
K  
L  
PCS  
N  
O  
P

# BCM (BODY CONTROL MODULE)

## [POWER DISTRIBUTION SYSTEM]

< ECU DIAGNOSIS >

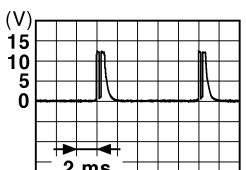
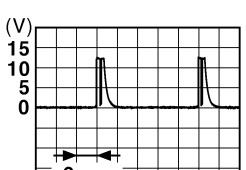
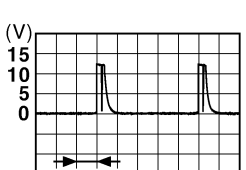
Terminal No. (Wire color)		Description		Condition	Value (Approx.)
(+)	(-)	Signal name	Input/ Output		
95 (R/W)	Ground	Combination switch INPUT 1	Input		
				Turn signal switch LH	 <p style="text-align: right; font-size: small;">JPMIA0037GB</p> <p style="text-align: center;">1.3V</p>
				Turn signal switch RH	 <p style="text-align: right; font-size: small;">JPMIA0036GB</p> <p style="text-align: center;">1.3V</p>
				Front wiper switch LO	 <p style="text-align: right; font-size: small;">JPMIA0038GB</p> <p style="text-align: center;">1.3V</p>
				Front washer switch ON	 <p style="text-align: right; font-size: small;">JPMIA0039GB</p> <p style="text-align: center;">1.3V</p>

# BCM (BODY CONTROL MODULE)

## [POWER DISTRIBUTION SYSTEM]

< ECU DIAGNOSIS >

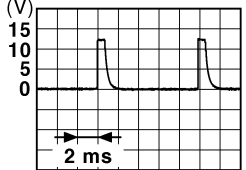
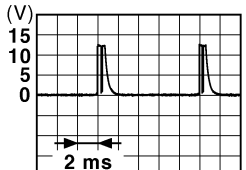
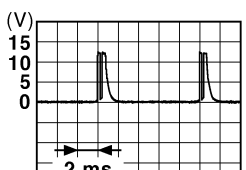
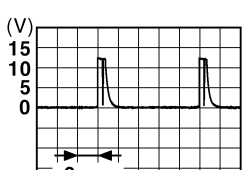
Terminal No. (Wire color)		Description		Condition	Value (Approx.)	
		Signal name	Input/ Output			
(+)	(-)					
96 (P/B)	Ground	Combination switch INPUT 4	Input	Combination switch	All switch OFF (Wiper intermittent dial 4)	 1.4V
					Lighting switch AUTO (Wiper intermittent dial 4)	 1.3V
					Lighting switch 1ST (Wiper intermittent dial 4)	 1.3V
					Any of the conditions below with all switch OFF • Wiper intermittent dial 1 • Wiper intermittent dial 5 • Wiper intermittent dial 6	 1.3V

A  
B  
C  
D  
E  
F  
G  
H  
I  
J  
K  
L

PCS

N  
O  
P

# BCM (BODY CONTROL MODULE)

## [POWER DISTRIBUTION SYSTEM]

< ECU DIAGNOSIS >

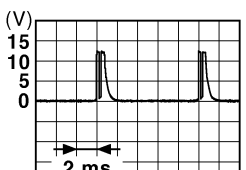
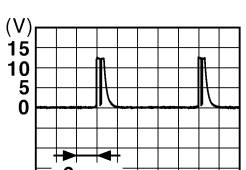
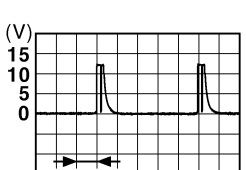
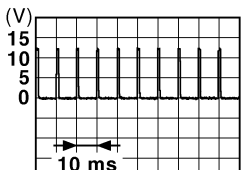
Terminal No. (Wire color)		Description		Condition	Value (Approx.)	
(+)	(-)	Signal name	Input/ Output			
97 (R/B)	Ground	Combination switch INPUT 2	Input			Combination switch (Wiper intermittent dial 4)
				Lighting switch flash-to-pass	 <small>JPMIA0037GB</small> 1.3V	
				Lighting switch 2ND	 <small>JPMIA0036GB</small> 1.3V	
				Front wiper switch INT	 <small>JPMIA0038GB</small> 1.3V	
				Front wiper switch HI	 <small>JPMIA0040GB</small> 1.3V	
				Pressed	0 V	
98 (G/O)	Ground	Hazard switch	Input	Hazard switch	Not pressed	 <small>JPMIA0012GB</small> 1.1V



# BCM (BODY CONTROL MODULE)

## [POWER DISTRIBUTION SYSTEM]

< ECU DIAGNOSIS >

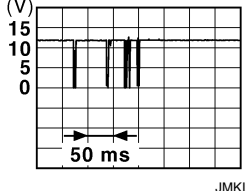
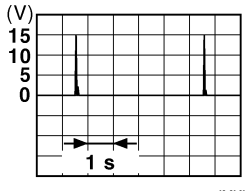
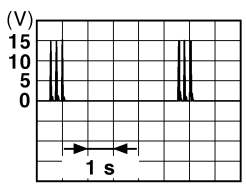
Terminal No. (Wire color)		Description		Condition	Value (Approx.)	
(+)	(-)	Signal name	Input/ Output			
99 <sup>3</sup> (L/Y)	Ground	Electronic steering column lock unit com- munication	Input/ Output	Electronic steer- ing column lock	LOCK status	Battery voltage
					LOCK or UNLOCK	
					For 15 seconds after UN- LOCK	Battery voltage
					15 seconds or later after UNLOCK	0V
103 (V)	Ground	Trunk lid opening.	Output	Trunk lid	Open (trunk lid opener ac- tuator is activated)	Battery voltage
					Close (trunk lid opener ac- tuator is not activated)	0V
110 (V/W)	Ground	Trunk room lamp	Output	Trunk room lamp	ON	0V
					OFF	Battery voltage
114 (B)	Ground	Trunk room antenna 1 (-)	Output	Ignition switch OFF	When Intelligent Key is in the passenger compart- ment	
					When Intelligent Key is not in the passenger compart- ment	

A  
B  
C  
D  
E  
F  
G  
H  
I  
J  
K  
L  
N  
O  
P

PCS

# BCM (BODY CONTROL MODULE)

## [POWER DISTRIBUTION SYSTEM]

< ECU DIAGNOSIS >

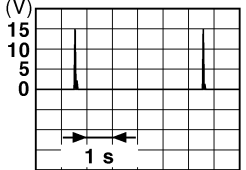
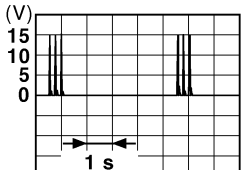
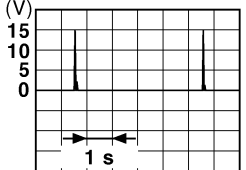
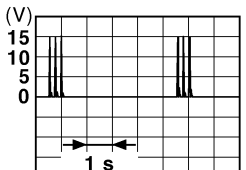
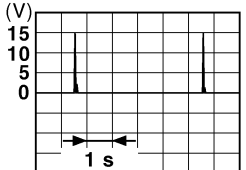
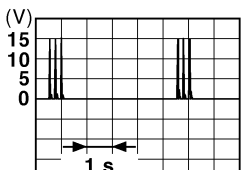
Terminal No. (Wire color)		Description		Condition	Value (Approx.)
(+)	(-)	Signal name	Input/ Output		
115 (W)	Ground	Trunk room antenna 1 (+)	Output	Ignition switch OFF	 <p style="text-align: right; font-size: small;">JMKIA0062GB</p>
				When Intelligent Key is not in the passenger compart- ment	 <p style="text-align: right; font-size: small;">JMKIA0063GB</p>
118 (L/O)	Ground	Rear bumper anten- na (-)	Output	When the trunk lid request switch is operated with ignition switch OFF	 <p style="text-align: right; font-size: small;">JMKIA0062GB</p>
				When Intelligent Key is not in the antenna detection area	 <p style="text-align: right; font-size: small;">JMKIA0063GB</p>
119 (BR/ W)	Ground	Rear bumper anten- na (+)	Output	When the trunk lid request switch is operated with ignition switch OFF	 <p style="text-align: right; font-size: small;">JMKIA0062GB</p>
				When Intelligent Key is not in the antenna detection area	 <p style="text-align: right; font-size: small;">JMKIA0063GB</p>

# BCM (BODY CONTROL MODULE)

## [POWER DISTRIBUTION SYSTEM]

< ECU DIAGNOSIS >

Terminal No. (Wire color)		Description		Condition	Value (Approx.)	
(+)	(-)	Signal name	Input/ Output			
127 (BR/ W)	Ground	Ignition relay (IPDM E/R) control	Output	Ignition switch	OFF or ACC	Battery voltage
					ON	0V
130 (W)	Ground	Trunk room lamp switch	Input	Trunk room lamp switch	OFF (trunk is closed)	<p style="text-align: right;">JPMIA0011GB 11.8V</p>
					ON (trunk is open)	0V
132 (R)	Ground	Starter motor relay control	Output	Ignition switch ON	When selector lever is in P or N position and the brake is depressed	Battery voltage
					When selector lever is in P or N position and the brake is not depressed	0V
140 <sup>4</sup> (L/R)	Ground	Engine switch (push switch)	Input	Engine switch (push switch)	Pressed	0V
					Not pressed	Battery voltage
141 (BR)	Ground	Trunk request switch	Input	Trunk request switch	ON (pressed)	0V
					OFF (not pressed)	<p style="text-align: right;">JPMIA0016GB 1.0V</p>
144 (GR)	Ground	Request switch buzz- er	Output	Request switch buzzer	Sounding	0V
					Not sounding	Battery voltage
147 (L/R)	Ground	Trunk lid opener switch	Input	Trunk lid opener switch	Pressed	0V
					Not pressed	Battery voltage
148 (R/W)	Ground	Rear door RH switch	Input	Rear door RH switch	OFF (when rear door RH closes)	<p style="text-align: right;">JPMIA0011GB 11.8V</p>
					ON (when rear door RH opens)	0V

A  
B  
C  
D  
E  
F  
G  
H  
I  
J  
K  
L  
PCS  
N  
O  
P

# BCM (BODY CONTROL MODULE)

< ECU DIAGNOSIS >

[POWER DISTRIBUTION SYSTEM]

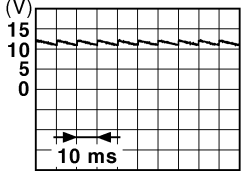
Terminal No. (Wire color)		Description		Condition		Value (Approx.)
(+)	(-)	Signal name	Input/ Output			
149 (R/B)	Ground	Rear door LH switch	Input	Rear door LH switch	OFF (when rear door LH closes)	 <p style="text-align: right; font-size: small;">JPMIA0011GB</p>
				ON (when rear door LH opens)	0V	

- 1 : With low tire pressure monitoring system
- 2 : With electronic steering column lock
- 3 : Early production
- 4 : Without electronic steering column lock

# BCM (BODY CONTROL MODULE)

## [POWER DISTRIBUTION SYSTEM]

< ECU DIAGNOSIS >

### Wiring Diagram

INFOID:000000005511883

#### BCM (BODY CONTROL MODULE)

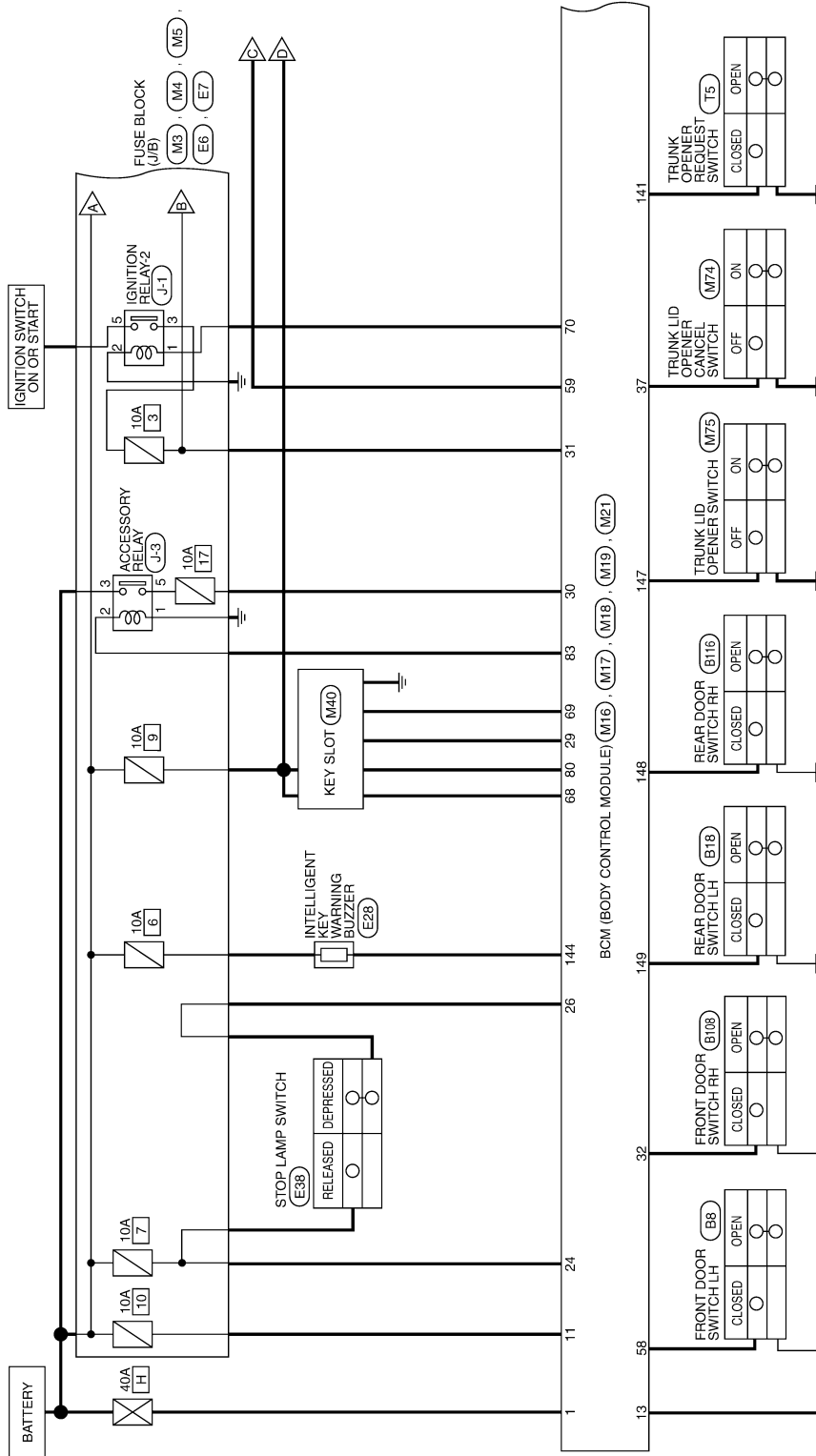

ABMWA0498GI

A  
B  
C  
D  
E  
F  
G  
H  
I  
J  
K  
L  
N  
O  
P

PCS

# BCM (BODY CONTROL MODULE)

## [POWER DISTRIBUTION SYSTEM]

< ECU DIAGNOSIS >

- ◊TP◊ : WITH LOW TIRE PRESSURE MONITORING SYSTEM
- ◊EH◊ : WITH ELECTRONIC STEERING COLUMN LOCK
- ◊EJ◊ : WITHOUT ELECTRONIC STEERING COLUMN LOCK

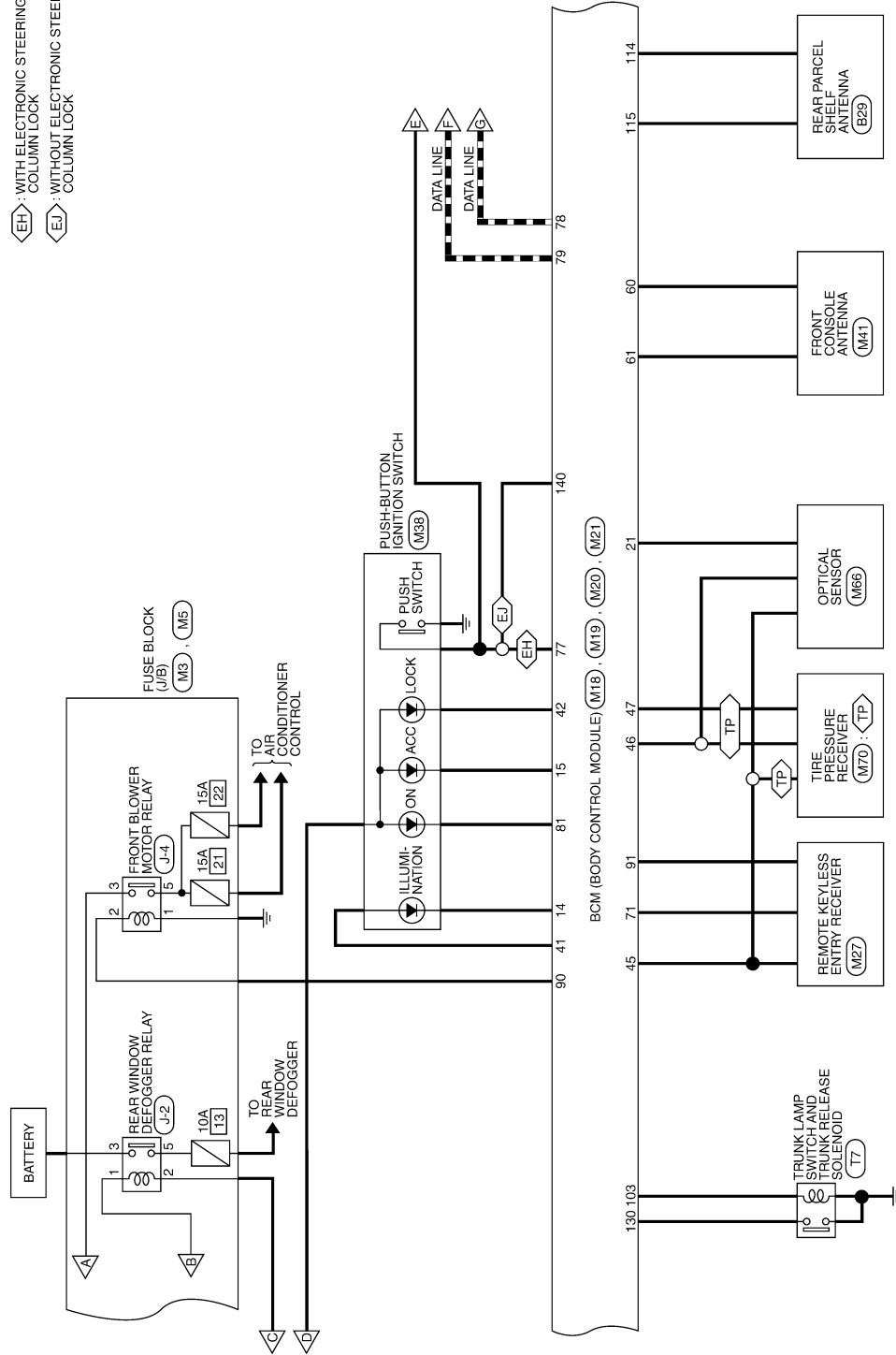

ABMWA0817GI

# BCM (BODY CONTROL MODULE)

## [POWER DISTRIBUTION SYSTEM]

< ECU DIAGNOSIS >

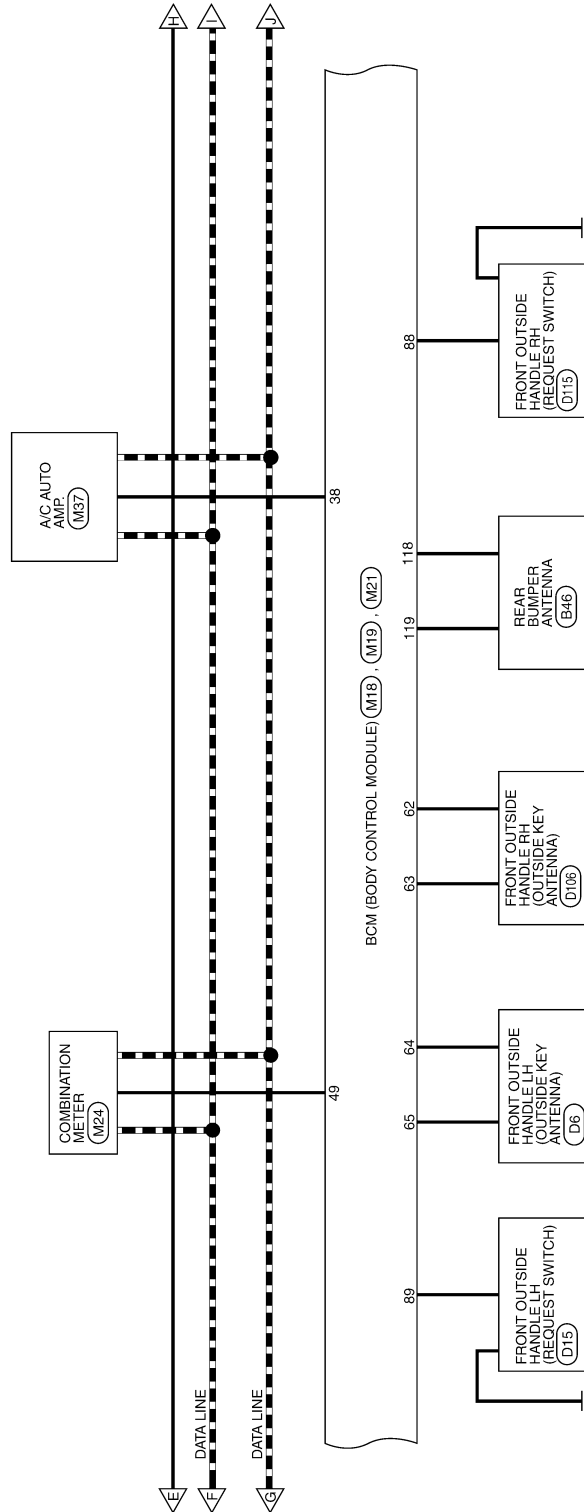

ABMWA0818GI

A  
B  
C  
D  
E  
F  
G  
H  
I  
J  
K  
L  
PCS  
N  
O  
P

# BCM (BODY CONTROL MODULE)

## [POWER DISTRIBUTION SYSTEM]

< ECU DIAGNOSIS >

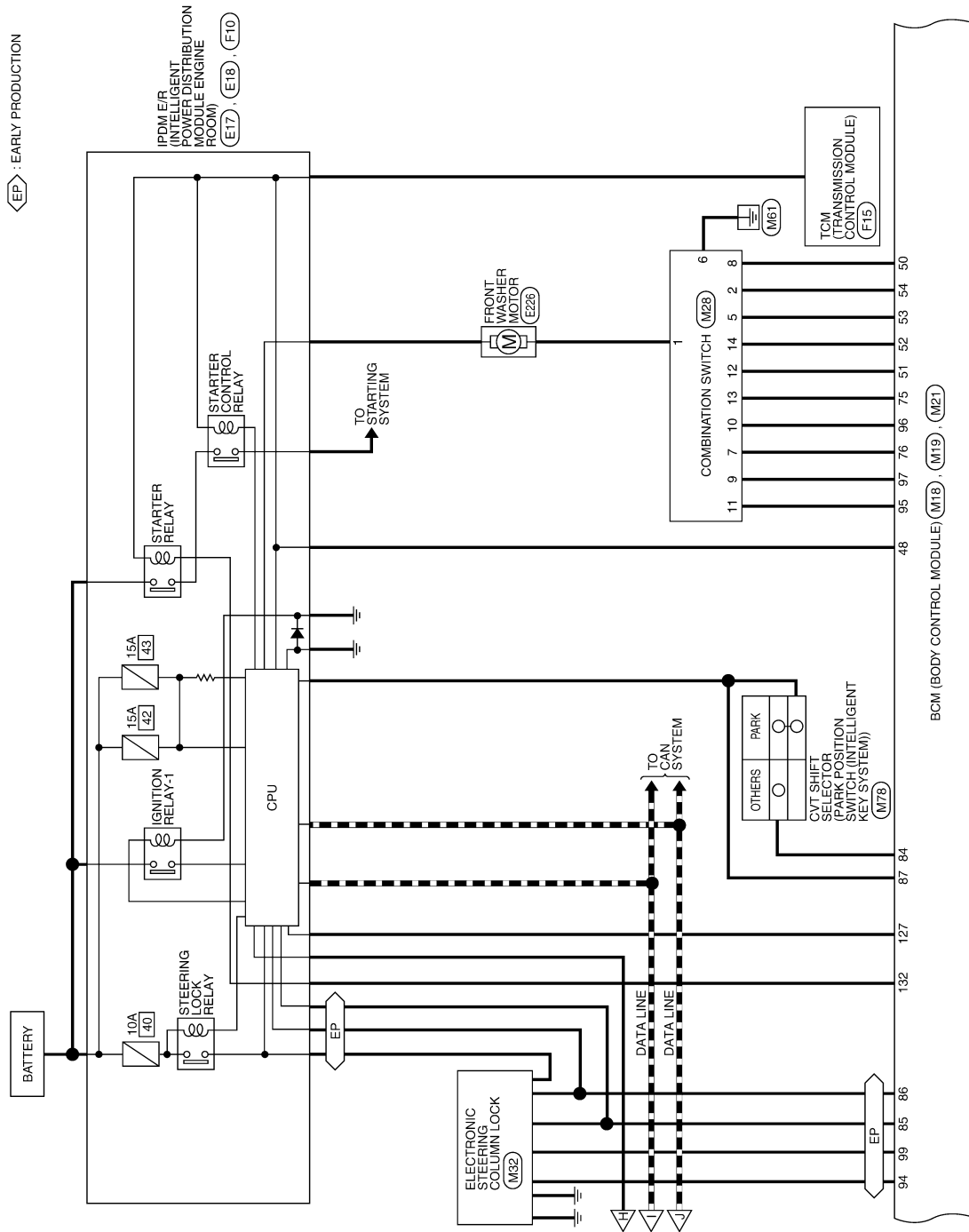

ABMWA0819GI



# BCM (BODY CONTROL MODULE)

## [POWER DISTRIBUTION SYSTEM]

< ECU DIAGNOSIS >

- <A2> : WITH LEFT AND RIGHT FRONT POWER WINDOW ANTI-PINCH SYSTEM
- <A3> : WITH FRONT AND REAR POWER WINDOW ANTI-PINCH SYSTEM
- <DP> : WITH DUAL PANEL SUNROOF
- <DW> : WITHOUT DUAL PANEL SUNROOF

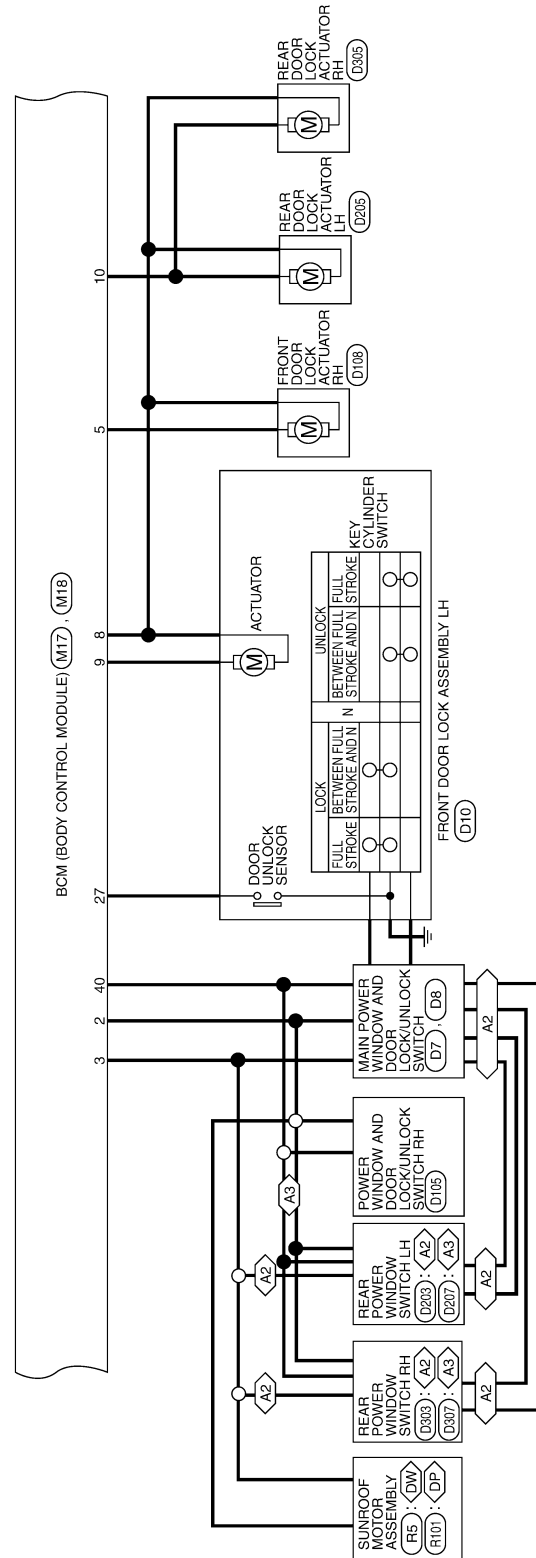

ABMWA0081GI

A  
B  
C  
D  
E  
F  
G  
H  
I  
J  
K  
L  
PCS  
N  
O  
P

# BCM (BODY CONTROL MODULE)

## [POWER DISTRIBUTION SYSTEM]

< ECU DIAGNOSIS >

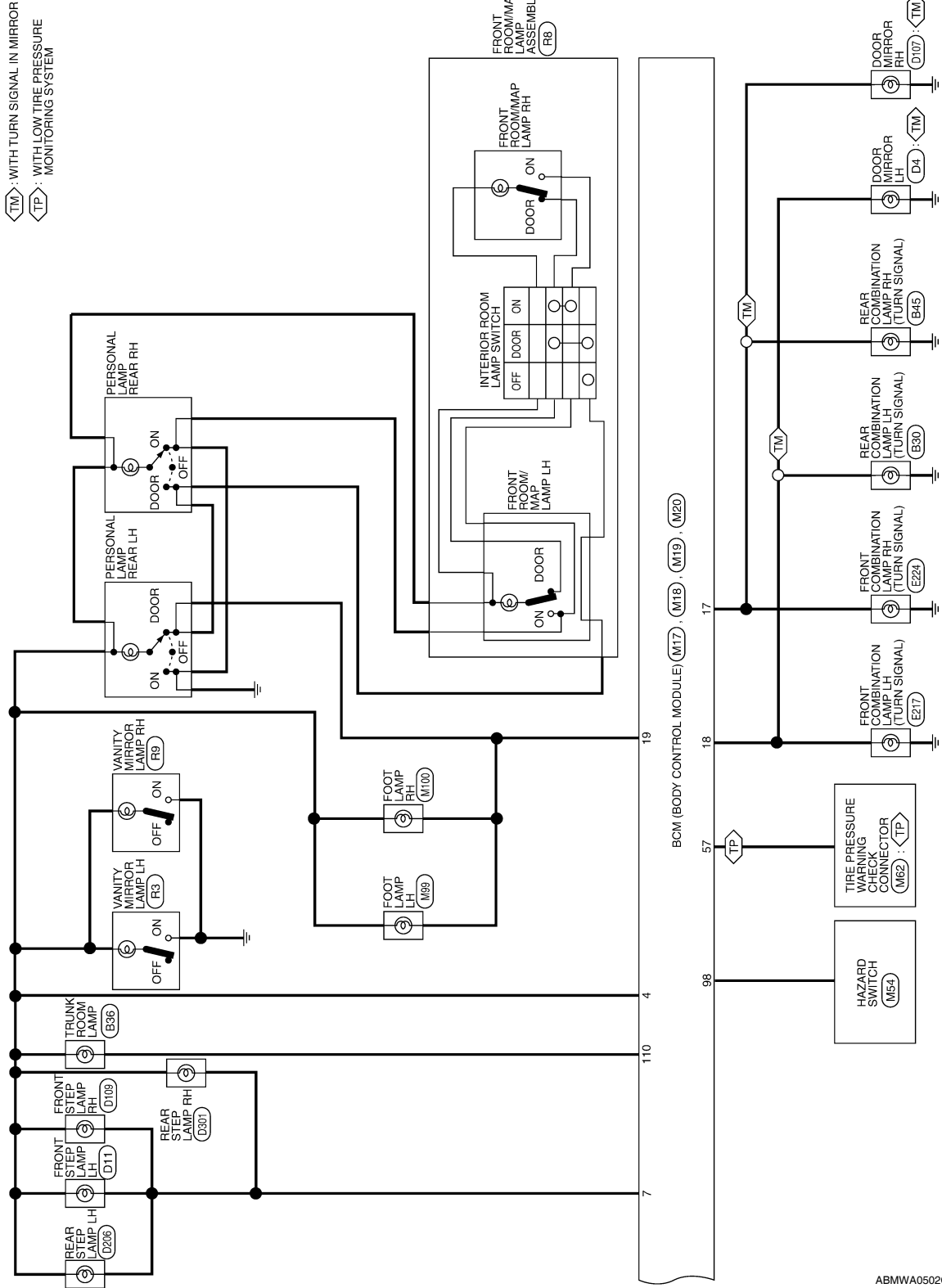

ABMWA0502GI

# BCM (BODY CONTROL MODULE)

[POWER DISTRIBUTION SYSTEM]

< ECU DIAGNOSIS >

## BCM (BODY CONTROL MODULE) CONNECTORS

Connector No.	M16
Connector Name	BCM (BODY CONTROL MODULE)
Connector Color	BLACK



Terminal No.	Color of Wire	Signal Name
1	W/B	BATT (F/L)
2	R/Y	P/W POWER SUPPLY PERM
3	L/W	P/W POWER SUPPLY IGN

Connector No.	M17
Connector Name	BCM (BODY CONTROL MODULE)
Connector Color	WHITE

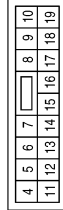

Terminal No.	Color of Wire	Signal Name
4	P/W	R/L POWER SUPPLY
5	G	DOOR UNLOCK OUTPUT AS
6	-	-
7	R/W	STEP LAMP CONT
8	V	DOOR LOCK OUTPUT ALL
9	L	DOOR UNLOCK OUTPUT (DR/FL)

Terminal No.	Color of Wire	Signal Name
10	G	DOOR UNLOCK OUTPUT (RR/RL)
11	Y/R	BAT BCM FUSE
12	-	-
13	B	GND1
14	GR/W	LOW SIDE PUSH LED
15	Y/L	ACC LED
16	-	-
17	G/B	FR FLASHER
18	G/Y	FL FLASHER
19	Y	ROOM LAMP CONT

Connector No.	M18
Connector Name	BCM (BODY CONTROL MODULE)
Connector Color	GREEN

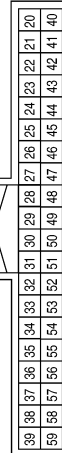

Terminal No.	Color of Wire	Signal Name
20	-	-
21	P/B	A/L SIGNAL TYPE 1
22	-	-
23	-	-
24	R/W	BRAKE SW1
25	-	-
26	O/L	BRAKE SW2

Terminal No.	Color of Wire	Signal Name
27	O	DOOR LOCK STATUS DR
28	-	-
29	Y	FOB IN SW 1
30	V/Y	ACC F/B
31	G	IGN F/B
32	R/B	AS DOOR SW 1
33	-	-
34	-	-
35	-	-
36	-	-
37	O	TRUNK CANCEL SW
38	GR/W	REAR DEFOGGER SW
39	-	-
40	Y/G	PW K-LINE
41	W	RING LED
42	R	S/L LOCK LED
43	-	-
44	-	-

Terminal No.	Color of Wire	Signal Name
45	P	GND RF2 A/L
46	V/W	A/L POWER SUPPLY 5V
47	G/O	RF2 TUNER SIGNAL
48	R/G	SHIFT N/P/NEUTRAL SW
49	L/O	IMMO LED (SECURITY INDICATOR)
50	LG/B	OUTPUT 5
51	L/W	OUTPUT 1
52	G/B	OUTPUT 2
53	LG/R	OUTPUT 3
54	G/Y	OUTPUT 4
55	-	-
56	-	-
57	W	TPMS MODE
58	SB	DR DOOR SW
59	G/R	REAR DEFOGGER

ABMIA1331GB

A B C D E F G H I J K L N O P

PCS

# BCM (BODY CONTROL MODULE)

## [POWER DISTRIBUTION SYSTEM]

< ECU DIAGNOSIS >

Connector No.	M19
Connector Name	BCM (BODY CONTROL MODULE)
Connector Color	BLACK



79	78	77	76	75	74	73	72	71	70	69	68	67	66	65	64	63	62	61	60
59	58	57	56	55	54	53	52	51	50	49	48	47	46	45	44	43	42	41	40

Terminal No.	Color of Wire	Signal Name
60	B/R	ROOM ANT 2 B
61	W/R	ROOM ANT 2 A
62	V	AS DOOR ANT B
63	P	AS DOOR ANT A
64	V	DR DOOR ANT B
65	P	DR DOOR ANT A
66	-	-

Terminal No.	Color of Wire	Signal Name
67	-	-
68	G/O	FOB READER CLOCK
69	O	FOB READER DATA
70	R/B	IGN REL OUTPUT 2
71	L/O	RF1 TUNER SIGNAL
72	-	-
73	-	-
74	-	-
75	R/Y	INPUT 5
76	R/G	INPUT 3
77	BR	ENG START SW
78	P	CAN-L
79	L	CAN-H
80	R/L	FOB SLOT ILLUMINATION
81	LG	IGN ON LED
82	-	-
83	L	ACC CONT

Terminal No.	Color of Wire	Signal Name
84	Y/R	AT DEVICE OUT
85	L/O	S/L CONDITION 1
86	G/R	S/L CONDITION 2
87	G/B	SHIFT P/ASCD CANCEL SW
88	R	AS REQUEST SW
89	R	DR REQUEST SW
90	Y	BLOWER FAN RELAY
91	L/R	RF POWER SUPPLY 12V
92	-	-
93	-	-
94	G/Y	S/L POWER SUPPLY 12V
95	R/W	INPUT 1
96	P/B	INPUT 4
97	R/B	INPUT 2
98	G/O	HAZARD SW
99	L/Y	S/L K-LINE

Connector No.	M20
Connector Name	BCM (BODY CONTROL MODULE)
Connector Color	WHITE



100	101	102	103	104		
105	106	107	108	109	110	111

Terminal No.	Color of Wire	Signal Name
100	-	-
101	-	-
102	-	-
103	V	CDL BACK TRUNK

Terminal No.	Color of Wire	Signal Name
104	-	-
105	-	-
106	-	-
107	-	-
108	-	-
109	-	-
110	V/W	TRUNK LAMP CONT
111	-	-

ABMIA1332GB

# BCM (BODY CONTROL MODULE)

## [POWER DISTRIBUTION SYSTEM]

< ECU DIAGNOSIS >

Terminal No.	Color of Wire	Signal Name
136	-	-
137	-	-
138	-	-
139	-	-
140	BR	ENG START SW W/O ESCL
141	BR	TRUNK REQUEST SW
142	-	-
143	-	-
144	GR	BUZZER
145	-	-
146	-	-
147	L/R	BACK TRUNK OPENER
148	R/W	RR DOOR SW
149	R/B	RL DOOR SW
150	-	-
151	-	-

Terminal No.	Color of Wire	Signal Name
119	BR/W	BACK DOOR ANT A
120	-	-
121	-	-
122	-	-
123	-	-
124	-	-
125	-	-
126	-	-
127	BR/W	IGN RELAY OUTPUT
128	-	-
129	-	-
130	W	TRUNK SW
131	-	-
132	R	ST RELAY OUTPUT
133	-	-
134	-	-
135	-	-

Terminal No.	Color of Wire	Signal Name
10	P/B	INPUT 4
11	R/W	INPUT 1
12	L/W	OUTPUT 1
13	R/Y	INPUT 5
14	G/B	OUTPUT 2

Connector No.	M21
Connector Name	BCM (BODY CONTROL MODULE)
Connector Color	GRAY

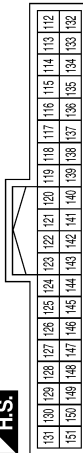

Terminal No.	Color of Wire	Signal Name
112	-	-
113	-	-
114	B	TRUNK ANT 1 B
115	W	TRUNK ANT 1 A
116	-	-
117	-	-
118	L/O	BACK DOOR ANT B

Connector No.	M28
Connector Name	COMBINATION SWITCH
Connector Color	WHITE

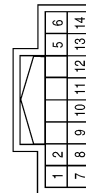

Terminal No.	Color of Wire	Signal Name
1	R/L	-
2	G/Y	OUTPUT 4
5	LG/R	OUTPUT 3
6	B	-
7	R/G	INPUT 3
8	LG/B	OUTPUT 5
9	R/B	INPUT 2

ABMIA2102GB

INFOID:000000005511884

### Fail Safe

Display contents of CONSULT	Fail-safe	Cancellation
B2013: ID DISCORD BCM-S/L *	Inhibit engine cranking	Erase DTC
B2014: CHAIN OF S/L-BCM *	Inhibit engine cranking	Erase DTC
B2190: NATS ANTENNA AMP	Inhibit engine cranking	Erase DTC

A  
B  
C  
D  
E  
F  
G  
H  
I  
J  
K  
L  
N  
O  
P

PCS

# BCM (BODY CONTROL MODULE)

## [POWER DISTRIBUTION SYSTEM]

### < ECU DIAGNOSIS >

Display contents of CONSULT	Fail-safe	Cancellation
B2191: DIFFERENCE OF KEY	Inhibit engine cranking	Erase DTC
B2192: ID DISCORD BCM-ECM	Inhibit engine cranking	Erase DTC
B2193: CHAIN OF BCM-ECM	Inhibit engine cranking	Erase DTC
B2195: ANTI-SCANNING	Inhibit engine cranking	Erase DTC
B2557: VEHICLE SPEED*	Inhibit electronic steering column lock	When normal vehicle speed signals have been received from ABS actuator and electric unit (control unit) for 500 ms
B2560: STARTER CONT RELAY	Inhibit engine cranking	500 ms after the following CAN signal communication status has become consistent <ul style="list-style-type: none"> <li>• Starter control relay signal</li> <li>• Starter relay status signal</li> </ul>
B2562: LO VOLTAGE	<ul style="list-style-type: none"> <li>• Inhibit engine cranking</li> <li>• Inhibit electronic steering column lock*</li> </ul>	100 ms after the power supply voltage increases to more than 8.8 V
B2601: SHIFT POSITION*	Inhibit electronic steering column lock	500 ms after the following signal reception status becomes consistent <ul style="list-style-type: none"> <li>• Selector lever P position switch signal</li> <li>• P range signal (CAN)</li> </ul>
B2602: SHIFT POSITION*	Inhibit electronic steering column lock	5 seconds after the following BCM recognition conditions are fulfilled <ul style="list-style-type: none"> <li>• Ignition switch is in the ON position</li> <li>• Selector lever P position switch signal: Except P position (battery voltage)</li> <li>• Vehicle speed: 4 km/h or more</li> </ul>
B2603: SHIFT POSI STATUS*	Inhibit electronic steering column lock	500 ms after the following BCM recognition conditions are fulfilled <ul style="list-style-type: none"> <li>• Ignition switch is in the ON position</li> <li>• Selector lever P position switch signal: Except P position (battery voltage)</li> <li>• Selector lever transmission range switch signal: Except P and N positions (0 V)</li> </ul>
B2604: TRANSMISSION RANGE SWITCH*	Inhibit electronic steering column lock	500 ms after any of the following BCM recognition conditions is fulfilled <ul style="list-style-type: none"> <li>• Status 1               <ul style="list-style-type: none"> <li>- Ignition switch is in the ON position</li> <li>- Selector lever transmission range switch signal: P and N position (battery voltage)</li> <li>- P range signal or N range signal (CAN): ON</li> </ul> </li> <li>• Status 2               <ul style="list-style-type: none"> <li>- Ignition switch is in the ON position</li> <li>- Selector lever transmission range switch signal: Except P and N positions (0 V)</li> <li>- P range signal and N range signal (CAN): OFF</li> </ul> </li> </ul>
B2605: TRANSMISSION RANGE SWITCH*	Inhibit electronic steering column lock	500 ms after any of the following BCM recognition conditions is fulfilled <ul style="list-style-type: none"> <li>• Ignition switch is in the ON position</li> <li>- Power position: IGN</li> <li>- Selector lever transmission range switch signal: Except P and N positions (0 V)</li> <li>- Transmission range switch signal (CAN): OFF</li> <li>• Status 2               <ul style="list-style-type: none"> <li>- Ignition switch is in the ON position</li> <li>- Selector lever transmission range switch signal: P or N position (battery voltage)</li> <li>- Transmission range switch signal (CAN): ON</li> </ul> </li> </ul>
B2606: S/L RELAY*	Inhibit engine cranking	500 ms after the following CAN signal communication status has become consistent <ul style="list-style-type: none"> <li>• Electronic steering column lock relay signal (Request signal)</li> <li>• Electronic steering column lock relay signal (Condition signal)</li> </ul>

# BCM (BODY CONTROL MODULE)

< ECU DIAGNOSIS >

[POWER DISTRIBUTION SYSTEM]

Display contents of CONSULT	Fail-safe	Cancellation
B2607: S/L RELAY*	Inhibit engine cranking	500 ms after the following CAN signal communication status has become consistent <ul style="list-style-type: none"> <li>Electronic steering column lock relay signal (Request signal)</li> <li>Electronic steering column lock relay signal (Condition signal)</li> </ul>
B2608: STARTER RELAY	Inhibit engine cranking	500 ms after the following signal communication status becomes consistent <ul style="list-style-type: none"> <li>Starter motor relay control signal</li> <li>Starter relay status signal (CAN)</li> </ul>
B2609: S/L STATUS*	<ul style="list-style-type: none"> <li>Inhibit engine cranking</li> <li>Inhibit electronic steering column lock</li> </ul>	When the following electronic steering column lock conditions agree <ul style="list-style-type: none"> <li>BCM electronic steering column lock control status</li> <li>Electronic steering column lock condition No. 1 signal status</li> <li>Electronic steering column lock condition No. 2 signal status</li> </ul>
B260A: IGNITION RELAY	Inhibit engine cranking	500 ms after the following conditions are fulfilled <ul style="list-style-type: none"> <li>IGN relay (IPDM E/R) control signal: OFF (Battery voltage)</li> <li>Ignition ON signal (CAN to IPDM E/R): OFF (Request signal)</li> <li>Ignition ON signal (CAN from IPDM E/R): OFF (Condition signal)</li> </ul>
B260F: ENG STATE SIG LOST	Maintains the power supply position attained at the time of DTC detection	When any of the following conditions is fulfilled <ul style="list-style-type: none"> <li>Power position changes to ACC</li> <li>Receives engine status signal (CAN)</li> </ul>
B2612: S/L STATUS*	<ul style="list-style-type: none"> <li>Inhibit engine cranking</li> <li>Inhibit electronic steering column lock</li> </ul>	When any of the following conditions is fulfilled <ul style="list-style-type: none"> <li>Electronic steering column lock unit status signal (CAN) is received normally</li> <li>The BCM electronic steering column lock control status matches the electronic steering column lock status recognized by the electronic steering column lock unit status signal (CAN from IPDM E/R)</li> </ul>
B2617: STARTER RELAY CIRC	Inhibit engine cranking	1 second after the starter motor relay control inside BCM becomes normal
B2618: BCM	Inhibit engine cranking	1 second after the ignition relay (IPDM E/R) control inside BCM becomes normal
B2619: BCM*	Inhibit engine cranking	1 second after the electronic steering column lock unit power supply output control inside BCM becomes normal
B26E1: ENG STATE NO RECIV	Inhibit engine cranking	When any of the following conditions are fulfilled <ul style="list-style-type: none"> <li>Power position changes to ACC</li> <li>Receives engine status signal (CAN)</li> </ul>

\* : With electronic steering column lock

## DTC Inspection Priority Chart

INFOID:000000005511885

If some DTCs are displayed at the same time, perform inspections one by one based on the following priority chart.

Priority	DTC
1	<ul style="list-style-type: none"> <li>B2562: LO VOLTAGE</li> </ul>
2	<ul style="list-style-type: none"> <li>U1000: CAN COMM CIRCUIT</li> <li>U1010: CONTROL UNIT (CAN)</li> </ul>
3	<ul style="list-style-type: none"> <li>B2190: NATS ANTENNA AMP</li> <li>B2191: DIFFERENCE OF KEY</li> <li>B2192: ID DISCORD BCM-ECM</li> <li>B2193: CHAIN OF BCM-ECM</li> </ul>

# BCM (BODY CONTROL MODULE)

< ECU DIAGNOSIS >

[POWER DISTRIBUTION SYSTEM]

Priority	DTC
4	<ul style="list-style-type: none"> <li>• B2013: ID DISCORD BCM-S/L*</li> <li>• B2014: CHAIN OF S/L-BCM*</li> <li>• B2553: IGNITION RELAY</li> <li>• B2555: STOP LAMP</li> <li>• B2556: PUSH-BTN IGN SW</li> <li>• B2557: VEHICLE SPEED</li> <li>• B2560: STARTER CONT RELAY</li> <li>• B2601: SHIFT POSITION</li> <li>• B2602: SHIFT POSITION</li> <li>• B2603: SHIFT POSI STATUS</li> <li>• B2604: TRANSMISSION RANGE SWITCH</li> <li>• B2605: TRANSMISSION RANGE SWITCH</li> <li>• B2606: S/L RELAY*</li> <li>• B2607: S/L RELAY*</li> <li>• B2608: STARTER RELAY</li> <li>• B2609: S/L STATUS*</li> <li>• B260A: IGNITION RELAY</li> <li>• B260B: STEERING LOCK UNIT*</li> <li>• B260C: STEERING LOCK UNIT*</li> <li>• B260D: STEERING LOCK UNIT*</li> <li>• B260F: ENG STATE SIG LOST</li> <li>• B2612: S/L STATUS*</li> <li>• B2614: ACC RELAY CIRC</li> <li>• B2615: BLOWER RELAY CIRC</li> <li>• B2616: IGN RELAY CIRC</li> <li>• B2617: STARTER RELAY CIRC</li> <li>• B2618: BCM</li> <li>• B2619: BCM*</li> <li>• B261A: PUSH-BTN IGN SW</li> <li>• B26E1: ENG STATE NO RECIV</li> <li>• C1729: VHCL SPEED SIG ERR</li> <li>• U0415: VEHICLE SPEED SIG</li> </ul>
5	<ul style="list-style-type: none"> <li>• C1704: LOW PRESSURE FL</li> <li>• C1705: LOW PRESSURE FR</li> <li>• C1706: LOW PRESSURE RR</li> <li>• C1707: LOW PRESSURE RL</li> <li>• C1708: [NO DATA] FL</li> <li>• C1709: [NO DATA] FR</li> <li>• C1710: [NO DATA] RR</li> <li>• C1711: [NO DATA] RL</li> <li>• C1712: [CHECKSUM ERR] FL</li> <li>• C1713: [CHECKSUM ERR] FR</li> <li>• C1714: [CHECKSUM ERR] RR</li> <li>• C1715: [CHECKSUM ERR] RL</li> <li>• C1716: [PRESSDATA ERR] FL</li> <li>• C1717: [PRESSDATA ERR] FR</li> <li>• C1718: [PRESSDATA ERR] RR</li> <li>• C1719: [PRESSDATA ERR] RL</li> <li>• C1720: [CODE ERR] FL</li> <li>• C1721: [CODE ERR] FR</li> <li>• C1722: [CODE ERR] RR</li> <li>• C1723: [CODE ERR] RL</li> <li>• C1724: [BATT VOLT LOW] FL</li> <li>• C1725: [BATT VOLT LOW] FR</li> <li>• C1726: [BATT VOLT LOW] RR</li> <li>• C1727: [BATT VOLT LOW] RL</li> <li>• C1734: CONTROL UNIT</li> </ul>
6	<ul style="list-style-type: none"> <li>• B2622: INSIDE ANTENNA</li> <li>• B2623: INSIDE ANTENNA</li> </ul>

\* : With electronic steering column lock



# BCM (BODY CONTROL MODULE)

[POWER DISTRIBUTION SYSTEM]

< ECU DIAGNOSIS >

## DTC Index

INFOID:000000005511886

### NOTE:

- Details of time display
- CRNT: Displays when there is a malfunction now or after returning to the normal condition until turning ignition switch OFF → ON again.
- 1 - 39: Displayed if any previous malfunction is present when current condition is normal. It increases 1 → 2 → 3...38 → 39 after returning to the normal condition whenever ignition switch OFF → ON. The counter remains at 39 even if the number of cycles exceeds it. It is counted from 1 again when turning ignition switch OFF → ON after returning to the normal condition if the malfunction is detected again.

CONSULT display	Fail-safe	Intelligent Key warning lamp ON	Tire pressure monitor warning lamp ON	Reference page
No DTC is detected. further testing may be required.	—	—	—	—
U1000: CAN COMM CIRCUIT	—	—	—	<a href="#">BCS-36</a>
U1010: CONTROL UNIT (CAN)	—	—	—	<a href="#">BCS-37</a>
U0415: VEHICLE SPEED SIG	—	—	—	<a href="#">BCS-38</a>
B2013: ID DISCORD BCM-S/L*	×	—	—	<a href="#">SEC-39</a>
B2014: CHAIN OF S/L-BCM*	×	—	—	<a href="#">SEC-40</a>
B2190: NATS ANTENNA AMP	×	—	—	<a href="#">SEC-43</a>
B2191: DIFFERENCE OF KEY	×	—	—	<a href="#">SEC-46</a>
B2192: ID DISCORD BCM-ECM	×	—	—	<a href="#">SEC-47</a>
B2193: CHAIN OF BCM-ECM	×	—	—	<a href="#">SEC-48</a>
B2553: IGNITION RELAY	—	—	—	<a href="#">PCS-55</a>
B2555: STOP LAMP	—	—	—	<a href="#">SEC-49</a>
B2556: PUSH-BTN IGN SW	—	×	—	<a href="#">SEC-52</a>
B2557: VEHICLE SPEED	×	×	—	<a href="#">SEC-54</a>
B2560: STARTER CONT RELAY	×	×	—	<a href="#">SEC-55</a>
B2562: LOW VOLTAGE	—	—	—	<a href="#">BCS-39</a>
B2601: SHIFT POSITION	×	×	—	<a href="#">SEC-56</a>
B2602: SHIFT POSITION	×	×	—	<a href="#">SEC-59</a>
B2603: SHIFT POSI STATUS	×	×	—	<a href="#">SEC-62</a>
B2604: TRANSMISSION RANGE SWITCH	×	×	—	<a href="#">SEC-65</a>
B2605: TRANSMISSION RANGE SWITCH	×	×	—	<a href="#">SEC-67</a>
B2606: S/L RELAY*	×	×	—	<a href="#">SEC-69</a>
B2607: S/L RELAY*	×	×	—	<a href="#">SEC-70</a>
B2608: STARTER RELAY	×	×	—	<a href="#">SEC-72</a>
B2609: S/L STATUS*	×	×	—	<a href="#">SEC-74</a>
B260A: IGNITION RELAY	×	×	—	<a href="#">PCS-57</a>
B260B: STEERING LOCK UNIT*	—	×	—	<a href="#">SEC-78</a>
B260C: STEERING LOCK UNIT*	—	×	—	<a href="#">SEC-79</a>
B260D: STEERING LOCK UNIT*	—	×	—	<a href="#">SEC-80</a>
B260F: ENG STATE SIG LOST	×	×	—	<a href="#">SEC-81</a>
B2612: S/L STATUS*	×	×	—	<a href="#">SEC-83</a>
B2614: ACC RELAY CIRC	—	×	—	<a href="#">PCS-59</a>

# BCM (BODY CONTROL MODULE)

< ECU DIAGNOSIS >

[POWER DISTRIBUTION SYSTEM]

CONSULT display	Fail-safe	Intelligent Key warning lamp ON	Tire pressure monitor warning lamp ON	Reference page
B2615: BLOWER RELAY CIRC	—	×	—	<a href="#">PCS-62</a>
B2616: IGN RELAY CIRC	—	×	—	<a href="#">PCS-65</a>
B2617: STARTER RELAY CIRC	×	×	—	<a href="#">PCS-65</a>
B2618: BCM	×	×	—	<a href="#">PCS-68</a>
B2619: BCM*	×	×	—	<a href="#">SEC-89</a>
B261A: PUSH-BTN IGN SW	—	×	—	<a href="#">SEC-90</a>
B2622: INSIDE ANTENNA	—	—	—	<a href="#">DLK-60</a>
B2623: INSIDE ANTENNA	—	—	—	<a href="#">DLK-63</a>
B26E1: ENG STATE NO RES	×	×	—	<a href="#">SEC-82</a>
C1704: LOW PRESSURE FL	—	—	×	<a href="#">WT-48</a>
C1705: LOW PRESSURE FR	—	—	×	<a href="#">WT-48</a>
C1706: LOW PRESSURE RR	—	—	×	<a href="#">WT-48</a>
C1707: LOW PRESSURE RL	—	—	×	<a href="#">WT-48</a>
C1708: [NO DATA] FL	—	—	×	<a href="#">WT-14</a>
C1709: [NO DATA] FR	—	—	×	<a href="#">WT-14</a>
C1710: [NO DATA] RR	—	—	×	<a href="#">WT-14</a>
C1711: [NO DATA] RL	—	—	×	<a href="#">WT-14</a>
C1712: [CHECKSUM ERR] FL	—	—	×	<a href="#">WT-16</a>
C1713: [CHECKSUM ERR] FR	—	—	×	<a href="#">WT-16</a>
C1714: [CHECKSUM ERR] RR	—	—	×	<a href="#">WT-16</a>
C1715: [CHECKSUM ERR] RL	—	—	×	<a href="#">WT-16</a>
C1716: [PRESSDATA ERR] FL	—	—	×	<a href="#">WT-18</a>
C1717: [PRESSDATA ERR] FR	—	—	×	<a href="#">WT-18</a>
C1718: [PRESSDATA ERR] RR	—	—	×	<a href="#">WT-18</a>
C1719: [PRESSDATA ERR] RL	—	—	×	<a href="#">WT-18</a>
C1720: [CODE ERR] FL	—	—	×	<a href="#">WT-16</a>
C1721: [CODE ERR] FR	—	—	×	<a href="#">WT-16</a>
C1722: [CODE ERR] RR	—	—	×	<a href="#">WT-16</a>
C1723: [CODE ERR] RL	—	—	×	<a href="#">WT-16</a>
C1724: [BATT VOLT LOW] FL	—	—	×	<a href="#">WT-16</a>
C1725: [BATT VOLT LOW] FR	—	—	×	<a href="#">WT-16</a>
C1726: [BATT VOLT LOW] RR	—	—	×	<a href="#">WT-16</a>
C1727: [BATT VOLT LOW] RL	—	—	×	<a href="#">WT-16</a>
C1729: VHCL SPEED SIG ERR	—	—	×	<a href="#">WT-20</a>
C1734: CONTROL UNIT	—	—	×	<a href="#">WT-21</a>

\* : With electronic steering column lock

# IPDM E/R (INTELLIGENT POWER DISTRIBUTION MODULE ENGINE ROOM)

< ECU DIAGNOSIS >

[POWER DISTRIBUTION SYSTEM]

## IPDM E/R (INTELLIGENT POWER DISTRIBUTION MODULE ENGINE ROOM)

Reference Value

INFOID:000000005511887

VALUES ON THE DIAGNOSIS TOOL

Monitor Item	Condition		Value/Status
MOTOR FAN REQ	Engine idle speed	Changes depending on engine coolant temperature, air conditioner operation status, vehicle speed, etc.	1,2,3,4
AC COMP REQ	Engine running	A/C switch OFF	Off
		A/C switch ON (Compressor is operating)	On
TAIL&CLR REQ	Lighting switch OFF		Off
	Lighting switch 1ST, 2ND, HI or AUTO (Light is illuminated)		On
HL LO REQ	Lighting switch OFF		Off
	Lighting switch 2ND HI or AUTO (Light is illuminated)		On
HL HI REQ	Lighting switch OFF		Off
	Lighting switch HI		On
FR FOG REQ	Lighting switch 2ND or AUTO (Light is illuminated)	Front fog lamp switch OFF	Off
		<ul style="list-style-type: none"> <li>• Front fog lamp switch ON</li> <li>• Daytime running light activated (Only for Canada models)</li> </ul>	On
FR WIP REQ	Ignition switch ON	Front wiper switch OFF	STOP
		Front wiper switch INT	1LOW
		Front wiper switch LO	Low
		Front wiper switch HI	Hi
WIP AUTO STOP	Ignition switch ON	Front wiper stop position	STOP P
		Any position other than front wiper stop position	ACT P
WIP PROT	Ignition switch ON	Front wiper operates normally	Off
		Front wiper stops at fail-safe operation	BLOCK
IGN RLY1 -REQ	Ignition switch OFF or ACC		Off
	Ignition switch ON		On
IGN RLY	Ignition switch OFF or ACC		Off
	Ignition switch ON		On
PUSH SW	Release the push-button ignition switch		Off
	Press the push-button ignition switch		On
INTER/NP SW	Ignition switch ON	CVT selector lever in any position other than P or N	Off
	Ignition switch ON	CVT selector lever in P or N position	On
ST RLY CONT	Ignition switch ON		Off
	At engine cranking		On
IHBT RLY -REQ	Ignition switch ON		Off
	At engine cranking		On

# IPDM E/R (INTELLIGENT POWER DISTRIBUTION MODULE ENGINE ROOM)

< ECU DIAGNOSIS >

[POWER DISTRIBUTION SYSTEM]

Monitor Item	Condition	Value/Status
ST/INHI RLY	Ignition switch ON	Off
	At engine cranking	ST →INHI
	The status of starter relay or starter control relay cannot be recognized by the battery voltage malfunction, etc. when the starter relay is ON and the starter control relay is OFF	UNKWN
DETENT SW	Ignition switch ON <ul style="list-style-type: none"> <li>• Press the selector button with CVT selector lever in P position</li> <li>• CVT selector lever in any position other than P</li> </ul>	Off
	Release the CVT selector button with CVT selector lever in P position	On
S/L RLY -REQ <sup>1</sup>	None of the conditions below are present	Off
	<ul style="list-style-type: none"> <li>• Open the driver door after the ignition switch is turned OFF (for a few seconds)</li> <li>• Press the push-button ignition switch when the steering lock is activated</li> </ul>	On
S/L STATE <sup>1</sup>	Steering lock is activated	LOCK
	Steering lock is deactivated	UNLK
	[DTC B210A] is detected	UNKWN
DTRL -REQ	DTRL ON	On
	DTRL OFF	Off
OIL P SW	Ignition switch OFF, ACC or engine running	Open
	Ignition switch ON	Close
THFT HRN REQ	Not operated	Off
	<ul style="list-style-type: none"> <li>• Panic alarm is activated</li> <li>• Horn is activated with VEHICLE SECURITY (THEFT WARNING) SYSTEM</li> </ul>	On
HORN CHIRP	Not operated	Off
	Door locking with Intelligent Key (horn chirp mode)	On

1: Early production

# IPDM E/R (INTELLIGENT POWER DISTRIBUTION MODULE ENGINE ROOM)

< ECU DIAGNOSIS >

[POWER DISTRIBUTION SYSTEM]

## TERMINAL LAYOUT

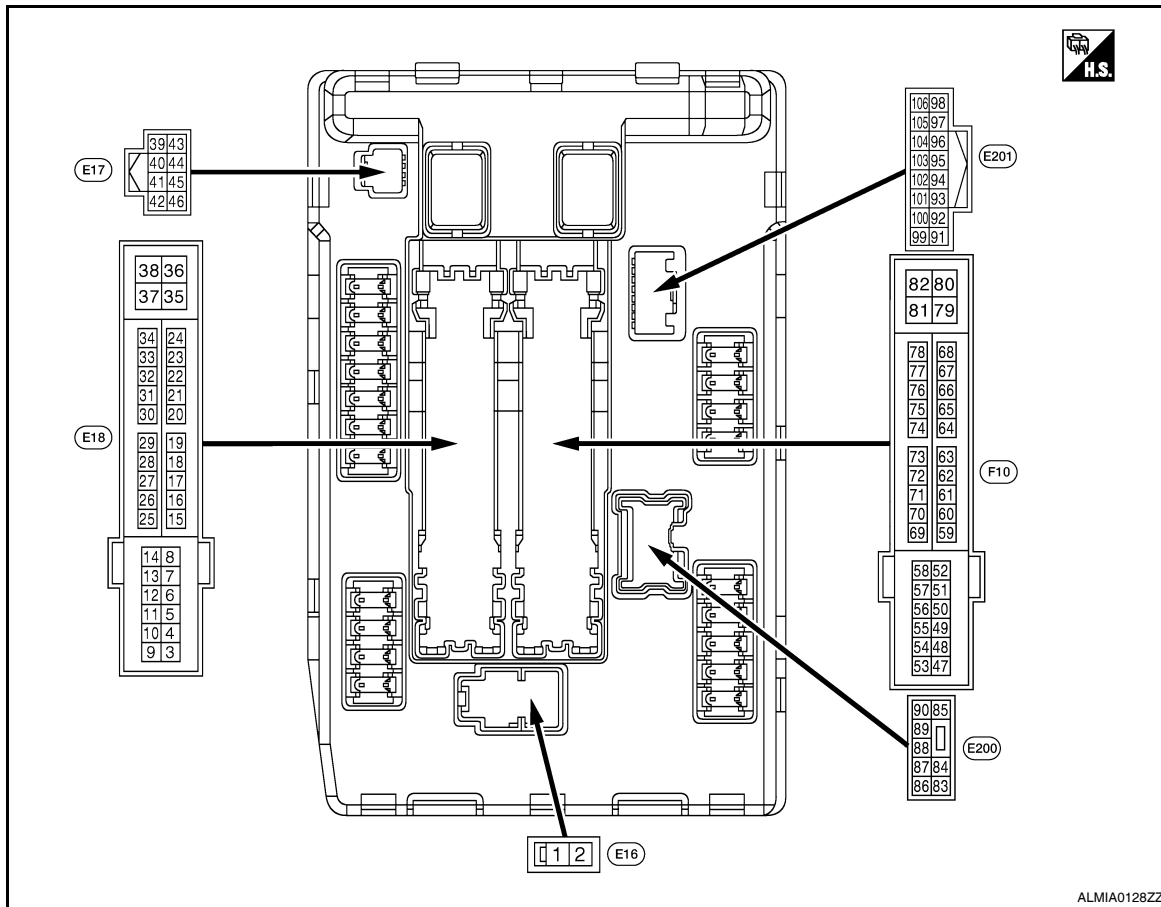

## PHYSICAL VALUES

Terminal No. (Wire color)		Description		Condition		Value (Approx.)
+	-	Signal name	Input/ Output			
1 (R)	Ground	Battery power supply	Input	Ignition switch OFF		Battery voltage
2 (L)	Ground	Battery power supply	Input	Ignition switch OFF		Battery voltage
4 (LG)	Ground	Front wiper LO	Output	Ignition switch OFF	Front wiper switch OFF	0 V
				Ignition switch ON	Front wiper switch LO	Battery voltage
5 (Y)	Ground	Front wiper HI	Output	Ignition switch OFF	Front wiper switch OFF	0 V
				Ignition switch ON	Front wiper switch HI	Battery voltage
6 (L)	Ground	Daytime light relay power supply (Canada models only)	Output	Ignition switch OFF		Battery voltage
7 (GR)	Ground	Tail, license plate lamps & interior lamps	Output	Ignition switch OFF	Lighting switch OFF	0 V
				Ignition switch ON	Lighting switch 1ST	Battery voltage
10 (BR)	Ground	ECM relay power supply	Output	Ignition switch OFF (For a few seconds after turning ignition switch OFF)		0 V
				<ul style="list-style-type: none"> <li>Ignition switch ON</li> <li>Ignition switch OFF (More than a few seconds after turning ignition switch OFF)</li> </ul>		Battery voltage

A  
B  
C  
D  
E  
F  
G  
H  
I  
J  
K  
L  
N  
O  
P

PCS

# IPDM E/R (INTELLIGENT POWER DISTRIBUTION MODULE ENGINE ROOM)

< ECU DIAGNOSIS >

[POWER DISTRIBUTION SYSTEM]

Terminal No. (Wire color)		Description		Condition		Value (Approx.)
+	-	Signal name	Input/ Output			
11 <sup>1</sup> (O)	Ground	Electronic steering column lock power supply	Output	Ignition switch OFF	A few seconds after opening the driver door	Battery voltage
				Ignition switch LOCK	Press the push-button ignition switch	Battery voltage
				Ignition switch ACC or ON		0 V
12 (B)	Ground	Ground	—	Ignition switch ON		0 V
13 (SB)	Ground	Fuel pump power supply	Output	Approximately 1 second or more after turning the ignition switch ON		0 V
				<ul style="list-style-type: none"> <li>• Approximately 1 second after turning the ignition switch ON</li> <li>• Engine running</li> </ul>		Battery voltage
15 (W)	Ground	Ignition relay-1 power supply	Output	Ignition switch OFF		0 V
				Ignition switch ON		Battery voltage
16 (R)	Ground	Front wiper auto stop	Input	Ignition switch ON	Front wiper stop position	0 V
					Any position other than front wiper stop position	Battery voltage
19 (Y)	Ground	Ignition relay-1 power supply	Output	Ignition switch OFF		0 V
				Ignition switch ON		Battery voltage
20 (L)	Ground	Ambient sensor ground	—	Ignition switch ON		0V
21 (LG)	Ground	Ambient sensor	—	Ignition switch ON		5V
22 (SB)	Ground	Refrigerant pressure sensor ground	—	Ignition switch ON		0V
23 (GR)	Ground	Refrigerant pressure sensor	—	<ul style="list-style-type: none"> <li>• Ignition switch ON (READY)</li> <li>• Both A/C switch and blower motor switch ON (electric compressor operates)</li> </ul>		1.0 - 4.0V
24 (G)	Ground	Refrigerant pressure sensor power supply	—	Ignition switch ON		5V
25 (GR)	Ground	Ignition relay-1 power supply	Output	Ignition switch OFF		0 V
				Ignition switch ON		Battery voltage
27 (W)	Ground	Ignition relay monitor	Input	Ignition switch OFF or ACC		Battery voltage
				Ignition switch ON		0 V
28 (SB)	Ground	Push-button ignition switch	Input	Press the push-button ignition switch		0 V
				Release the push-button ignition switch		Battery voltage
30 (BR)	Ground	Starter relay control	Input	CVT selector lever in any position other than P or N (ignition switch ON)		0 V
				CVT selector lever P or N (ignition switch ON)		Battery voltage
32 <sup>1</sup> (P)	Ground	Electronic steering column lock unit condition-1	Input	Electronic steering column lock is activated		0 V
				Electronic steering column lock is deactivated		Battery voltage

# IPDM E/R (INTELLIGENT POWER DISTRIBUTION MODULE ENGINE ROOM)

< ECU DIAGNOSIS >

[POWER DISTRIBUTION SYSTEM]

Terminal No. (Wire color)		Description		Condition	Value (Approx.)		
		Signal name	Input/ Output				
+	-						
33 <sup>1</sup> (G)	Ground	Electronic steering column lock condition-2	Input	Electronic steering column lock is activated	Battery voltage	A	
				Electronic steering column lock is deactivated	0 V	B	
34 (O)	Ground	Cooling fan relay-3 control	Input	Ignition switch OFF or ACC	0 V	C	
				Ignition switch ON	0.7 V		
35 (P)	Ground	Cooling fan motor control	Output	Ignition switch OFF or ACC	0 V	D	
				Ignition switch ON	0.7 V		
36 (G)	Ground	Battery power supply	Input	Ignition switch OFF	Battery voltage	E	
38 (GR)	Ground	Cooling fan motor control	Output	Ignition switch OFF or ACC	0 V		
				Ignition switch ON	0.7 V		
39 (P)	—	CAN - L	Input/ Output	—	—	F	
40 (L)	—	CAN - H	Input/ Output	—	—	G	
41 (B)	Ground	Ground	—	Ignition switch ON	0 V		
42 (SB)	Ground	Cooling fan relay-2 control	Input	Ignition switch OFF or ACC	0 V	H	
				Ignition switch ON	0.7 V		
43 (Y)	Ground	CVT shift selector (Detention switch)	Input	Ignition switch ON	Press the CVT selector button (CVT selector lever P)	Battery voltage	I
					<ul style="list-style-type: none"> <li>• CVT selector lever in any position other than P</li> <li>• Release the CVT selector button (CVT selector lever P)</li> </ul>	0 V	J
44 (W)	Ground	Horn relay control	Input	The horn is deactivated	Battery voltage		
				The horn is activated	0 V	L	
45 (GR)	Ground	Anti theft horn relay control	Input	The horn is deactivated	Battery voltage		
				The horn is activated	0 V		
46 (BR)	Ground	Starter relay control	Input	CVT selector lever in any position other than P or N (ignition switch ON)	0 V	PCS	
				CVT selector lever P or N (ignition switch ON)	Battery voltage	N	
48 (W)	Ground	A/C relay power supply	Output	Engine running	A/C switch OFF	0 V	
					A/C switch ON (A/C compressor is operating)	Battery voltage	O
49 (R/G)	Ground	ECM relay power supply	Output	Ignition switch OFF (For a few seconds after turning ignition switch OFF)	0 V	P	
				<ul style="list-style-type: none"> <li>• Ignition switch ON</li> <li>• Ignition switch OFF (More than a few seconds after turning ignition switch OFF)</li> </ul>	Battery voltage		
51 (LG)	Ground	Ignition relay power supply	Output	Ignition switch OFF	0 V		
				Ignition switch ON	Battery voltage		

# IPDM E/R (INTELLIGENT POWER DISTRIBUTION MODULE ENGINE ROOM)

< ECU DIAGNOSIS >

[POWER DISTRIBUTION SYSTEM]

Terminal No. (Wire color)		Description		Condition		Value (Approx.)
+	-	Signal name	Input/ Output			
52 (Y/G)	Ground	Ignition relay power supply	Output	Ignition switch OFF		0 V
				Ignition switch ON		Battery voltage
53 (R/W)	Ground	ECM relay power supply	Output	Ignition switch OFF (For a few seconds after turning ignition switch OFF)		0 V
				<ul style="list-style-type: none"> <li>• Ignition switch ON</li> <li>• Ignition switch OFF (More than a few seconds after turning ignition switch OFF)</li> </ul>		Battery voltage
54 (G/W)	Ground	Throttle control motor relay power supply	Output	Ignition switch OFF (For a few seconds after turning ignition switch OFF)		0 V
				<ul style="list-style-type: none"> <li>• Ignition switch ON</li> <li>• Ignition switch OFF (More than a few seconds after turning ignition switch OFF)</li> </ul>		Battery voltage
55 (W/L)	Ground	ECM power supply	Output	Ignition switch OFF		Battery voltage
56 (R/Y)	Ground	Ignition relay power supply	Output	Ignition switch OFF		0 V
				Ignition switch ON		Battery voltage
57 (O)	Ground	Ignition relay power supply	Output	Ignition switch OFF		0 V
				Ignition switch ON		Battery voltage
58 (Y)	Ground	Ignition relay power supply	Output	Ignition switch OFF		0 V
				Ignition switch ON		Battery voltage
69 (W/B)	Ground	ECM relay control	Output	Ignition switch OFF (For a few seconds after turning ignition switch OFF)		Battery voltage
				<ul style="list-style-type: none"> <li>• Ignition switch ON</li> <li>• Ignition switch OFF (More than a few seconds after turning ignition switch OFF)</li> </ul>		0 - 1.5 V
70 (O)	Ground	Throttle control motor relay control	Output	Ignition switch ON → OFF		0 -1.0 V ↓ Battery voltage ↓ 0 V
				Ignition switch ON		0 - 1.0 V
72 (R/B)	Ground	Transmission range switch signal	Input	Ignition switch ON	CVT selector lever in P or N position	Battery voltage
					CVT selector lever in any position other than P or N position	0 V
75 (LG)	Ground	Oil pressure switch	Input	Ignition switch ON	Engine stopped	0 V
					Engine running	Battery voltage



# IPDM E/R (INTELLIGENT POWER DISTRIBUTION MODULE ENGINE ROOM)

< ECU DIAGNOSIS >

[POWER DISTRIBUTION SYSTEM]

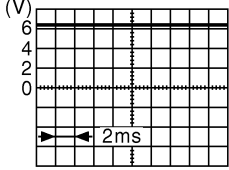
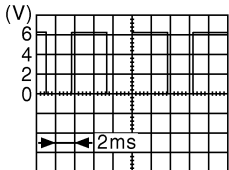
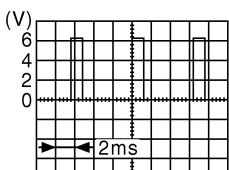
Terminal No. (Wire color)		Description		Condition		Value (Approx.)
+	-					
76 (SB)	Ground	Power generation command signal	Output	Ignition switch ON		 6.3 V
				40% is set on "Active test", "ALTERNATOR DUTY" of "ENGINE"		 3.8 V
				80% is set on "Active test", "ALTERNATOR DUTY" of "ENGINE"		 1.4 V
77 (GR)	Ground	Fuel pump relay control	Output	<ul style="list-style-type: none"> <li>• Approximately 1 second after turning the ignition switch ON</li> <li>• Engine running</li> </ul>		0 - 1.0 V
				Approximately 1 second or more after turning the ignition switch ON		Battery voltage
80 (B/W)	Ground	Starter motor	Output	At engine cranking		Battery voltage
83 (R/Y)	Ground	Headlamp LO (RH)	Output	Ignition switch ON	Lighting switch OFF	0 V
					Lighting switch 2ND	Battery voltage
84 (L)	Ground	Headlamp LO (LH)	Output	Ignition switch ON	Lighting switch OFF	0 V
					Lighting switch 2ND	Battery voltage
86 (W/R)	Ground	Front fog lamp (RH)	Output	Lighting switch 2ND	<ul style="list-style-type: none"> <li>• Front fog lamp switch ON</li> <li>• Daytime running light activated (Only for Canada models)</li> </ul>	Battery voltage
					Front fog lamp switch OFF	0 V
87 (L/Y)	Ground	Front fog lamp (LH)	Output	Lighting switch 2ND	<ul style="list-style-type: none"> <li>• Front fog lamp switch ON</li> <li>• Daytime running light activated (Only for Canada models)</li> </ul>	Battery voltage
					Front fog lamp switch OFF	0 V
88 (R/W)	Ground	Washer pump power supply	Output	Ignition switch ON		Battery voltage

A  
B  
C  
D  
E  
F  
G  
H  
I  
J  
K  
L

PCS

N  
O  
P

# IPDM E/R (INTELLIGENT POWER DISTRIBUTION MODULE ENGINE ROOM)

< ECU DIAGNOSIS >

[POWER DISTRIBUTION SYSTEM]

Terminal No. (Wire color)		Description		Condition		Value (Approx.)
+	-	Signal name	Input/ Output			
89 (L/W)	Ground	Headlamp HI (RH)	Output	Ignition switch ON	• Lighting switch HI • Lighting switch PASS	Battery voltage
					Lighting switch OFF	0 V
90 (G)	Ground	Headlamp HI (LH)	Output	Ignition switch ON	• Lighting switch HI • Lighting switch PASS	Battery voltage
					Lighting switch OFF	0 V
91 (LG/ R)	Ground	Parking lamp (RH)	Output	Ignition switch ON	Lighting switch 1ST	Battery voltage
					Lighting switch OFF	0 V
92 (LG/ B)	Ground	Parking lamp (LH)	Output	Ignition switch ON	Lighting switch 1ST	Battery voltage
					Lighting switch OFF	0 V
99 (BR/ W)	Ground	Ambient sensor ground	—	Ignition switch ON		0V
100 (SB)	Ground	Ambient sensor	—	Ignition switch ON		5V
101 (W)	Ground	Refrigerant pressure sensor ground	—	Ignition switch ON		0V
102 (R)	Ground	Refrigerant pressure sensor	—	• Ignition switch ON (READY) • Both A/C switch and blower motor switch ON (electric compressor operates)		1.0 - 4.0V
103 (P)	Ground	Refrigerant pressure sensor power supply	—	Ignition switch ON		5V
105 (V)	Ground	Daytime light relay control (Only for Canada models)	Output	Ignition switch ON	Daytime light system active	Battery voltage
				Ignition switch ON	Daytime light system inactive	0 V

1: Early production

# IPDM E/R (INTELLIGENT POWER DISTRIBUTION MODULE ENGINE ROOM)

< ECU DIAGNOSIS >

[POWER DISTRIBUTION SYSTEM]

## Wiring Diagram

INFOID:000000005460660

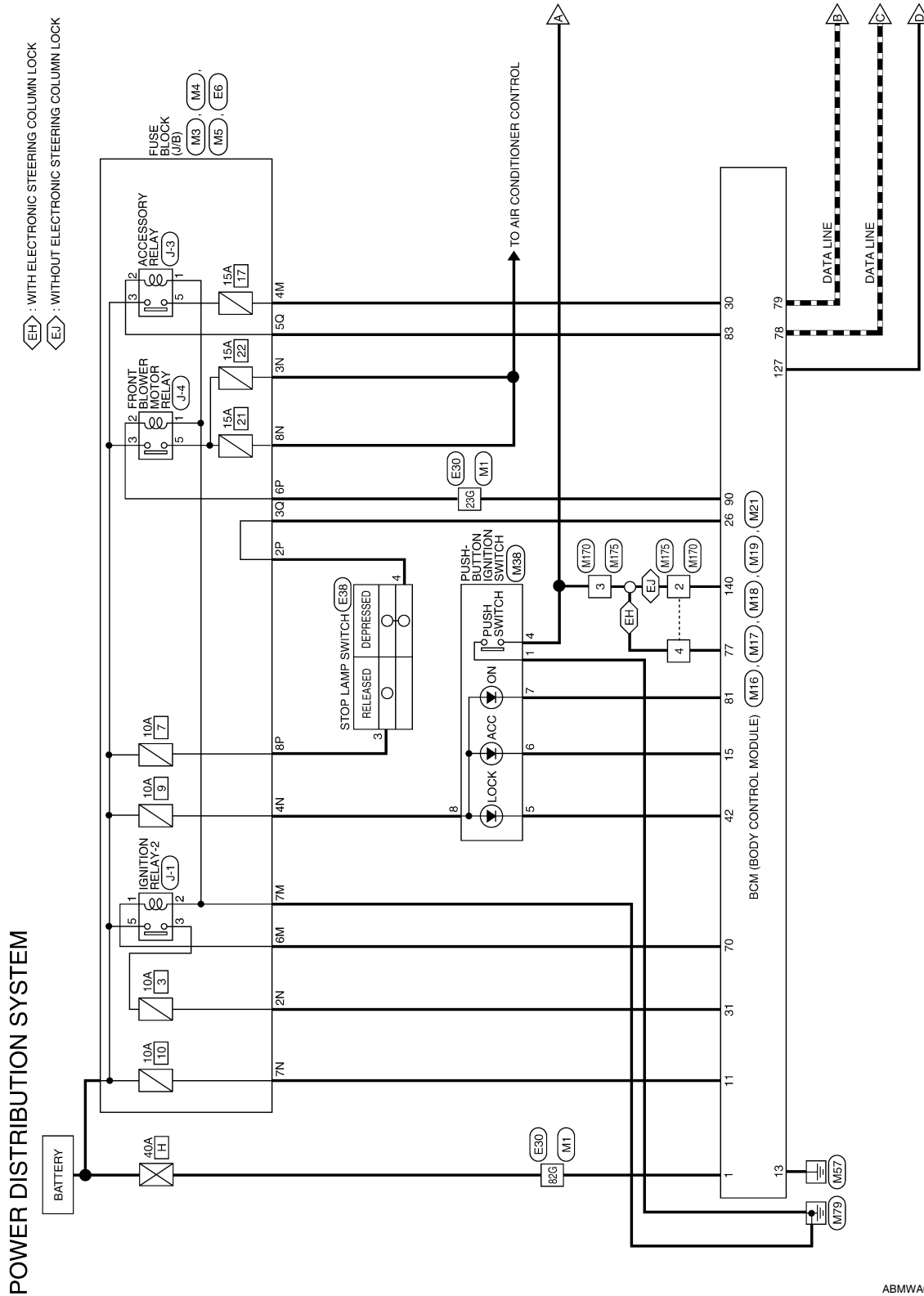

A  
B  
C  
D  
E  
F  
G  
H  
I  
J  
K  
L  
M  
N  
O  
P

PCS

ABMWA0822GI

**IPDM E/R (INTELLIGENT POWER DISTRIBUTION MODULE ENGINE ROOM)**  
**< ECU DIAGNOSIS >** **[POWER DISTRIBUTION SYSTEM]**

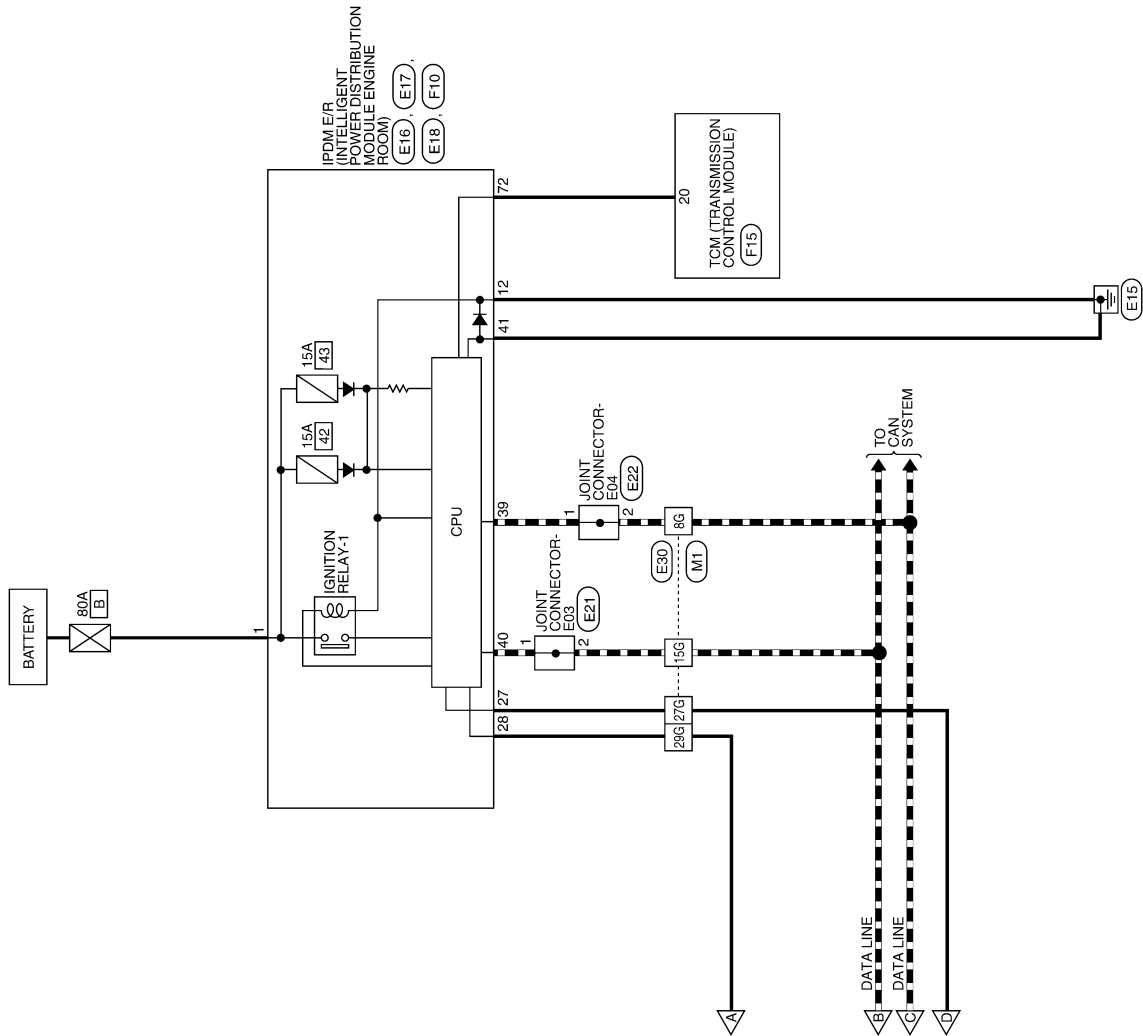

ABMWA0510GI

## POWER DISTRIBUTION SYSTEM CONNECTORS

Connector No.	M1
Connector Name	WIRE TO WIRE
Connector Color	WHITE

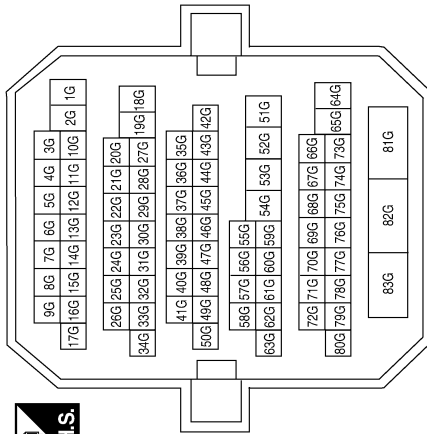

Terminal No.	Color of Wire	Signal Name
8G	P	-
15G	L	-
23G	Y	-
27G	BR/W	-
29G	BR	-
82G	W/B	-

Connector No.	M3
Connector Name	FUSE BLOCK (J/B)
Connector Color	WHITE

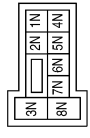

Terminal No.	Color of Wire	Signal Name
2N	G	-
3N	W/L	-
4N	G/Y	-
7N	Y/R	-
8N	W/L	-

Connector No.	M4
Connector Name	FUSE BLOCK (J/B)
Connector Color	WHITE

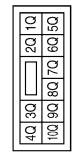

Terminal No.	Color of Wire	Signal Name
3Q	O/L	-
5Q	L	-

Connector No.	M5
Connector Name	FUSE BLOCK (J/B)
Connector Color	WHITE

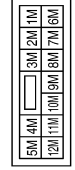

Terminal No.	Color of Wire	Signal Name
4M	V/Y	-
6M	R/B	-
7M	B	-

Connector No.	M16
Connector Name	BCM (BODY CONTROL MODULE)
Connector Color	BLACK



Terminal No.	Color of Wire	Signal Name
1	W/B	BATT (F/L)

A  
B  
C  
D  
E  
F  
G  
H  
I  
J  
K  
L  
N  
O  
P

PCS

ABMIA0854GB

# IPDM E/R (INTELLIGENT POWER DISTRIBUTION MODULE ENGINE ROOM)

< ECU DIAGNOSIS >

[POWER DISTRIBUTION SYSTEM]

Connector No.	M17
Connector Name	BCM (BODY CONTROL MODULE)
Connector Color	WHITE

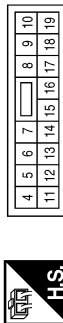

Terminal No.	Color of Wire	Signal Name
11	Y/R	BAT BCM FUSE
13	B	GND1
15	Y/L	ACC LED

Connector No.	M18
Connector Name	BCM (BODY CONTROL MODULE)
Connector Color	GREEN



Terminal No.	Color of Wire	Signal Name
26	O/L	BRAKE SW2
30	V/Y	ACC F/B
31	G	IGN F/B
42	R	S/L LOCK LED

Connector No.	M19
Connector Name	BCM (BODY CONTROL MODULE)
Connector Color	BLACK



Terminal No.	Color of Wire	Signal Name
70	R/B	IGN REL OUTPUT2
77	BR	ENG START SW
78	P	CAN-L
79	L	CAN-H
81	LG	IGN ON LED
83	L	ACC CONT
90	Y	BLOWER FAN RELAY

Connector No.	M21
Connector Name	BCM (BODY CONTROL MODULE)
Connector Color	GRAY



Terminal No.	Color of Wire	Signal Name
127	BR/W	IGN RELAY OUTPUT
140	BR	ENG START SW W/O ESCL

Connector No.	M38
Connector Name	PUSH-BUTTON IGNITION SWITCH
Connector Color	BROWN



Terminal No.	Color of Wire	Signal Name
1	B	-
4	BR	-
5	R	-
6	Y/L	-
7	LG	-
8	G/Y	-

Connector No.	M170
Connector Name	ESCL JUMPER-1
Connector Color	WHITE



Terminal No.	Color of Wire	Signal Name
1	-	-
2	BR	-
3	BR	-
4	BR	-

# IPDM E/R (INTELLIGENT POWER DISTRIBUTION MODULE ENGINE ROOM)

< ECU DIAGNOSIS >

[POWER DISTRIBUTION SYSTEM]

Connector No.	E16
Connector Name	IPDM E/R (INTELLIGENT POWER DISTRIBUTION MODULE ENGINE ROOM)
Connector Color	BLACK



Terminal No.	Color of Wire	Signal Name
1	R	F/L MAIN

Connector No.	E6
Connector Name	FUSE BLOCK (J/B)
Connector Color	WHITE



Terminal No.	Color of Wire	Signal Name
2P	LG	-
6P	Y	-
8P	R	-

Connector No.	M175
Connector Name	ESCL JUMPER-2
Connector Color	WHITE

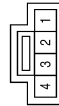

Terminal No.	Color of Wire	Signal Name
1	-	-
2	BR	-
3	BR	-
4	BR	-

Connector No.	E21
Connector Name	JOINT CONNECTOR-E03
Connector Color	WHITE



Terminal No.	Color of Wire	Signal Name
1	L	-
2	L	-

Connector No.	E18
Connector Name	IPDM E/R (INTELLIGENT POWER DISTRIBUTION MODULE ENGINE ROOM)
Connector Color	WHITE

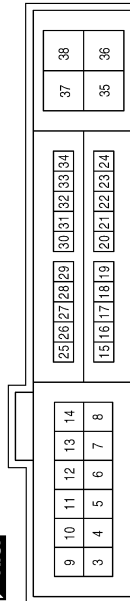

Terminal No.	Color of Wire	Signal Name
12	B	GND (POWER)
27	W	IGN SIGNAL
28	SB	PUSH START SW

Connector No.	E17
Connector Name	IPDM E/R (INTELLIGENT POWER DISTRIBUTION MODULE ENGINE ROOM)
Connector Color	WHITE

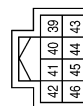

Terminal No.	Color of Wire	Signal Name
39	P	CAN-L
40	L	CAN-H
41	B	GND (SIGNAL)

ABMIA2105GB

A  
B  
C  
D  
E  
F  
G  
H  
I  
J  
K  
L  
N  
O  
P

PCS

# IPDM E/R (INTELLIGENT POWER DISTRIBUTION MODULE ENGINE ROOM)

< ECU DIAGNOSIS >

[POWER DISTRIBUTION SYSTEM]

Terminal No.	Color of Wire	Signal Name
8G	P	-
15G	L	-
23G	Y	-
27G	W	-
29G	SB	-
82G	LG	-

Connector No.	E30
Connector Name	WIRE TO WIRE
Connector Color	WHITE

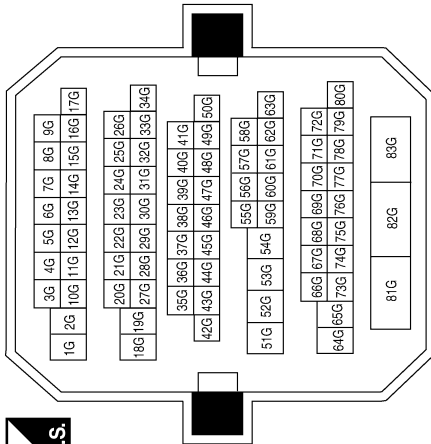

Connector No.	E22
Connector Name	JOINT CONNECTOR-E04
Connector Color	WHITE



Terminal No.	Color of Wire	Signal Name
1	P	-
2	P	-

Connector No.	F15
Connector Name	TCM (TRANSMISSION CONTROL MODULE)
Connector Color	WHITE

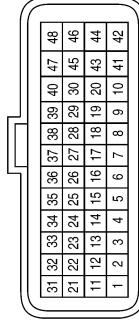

Terminal No.	20	Color of Wire	R/B	Signal Name	ST RLY
--------------	----	---------------	-----	-------------	--------

Connector No.	F10
Connector Name	IPDM E/R (INTELLIGENT POWER DISTRIBUTION MODULE ENGINE ROOM)
Connector Color	WHITE

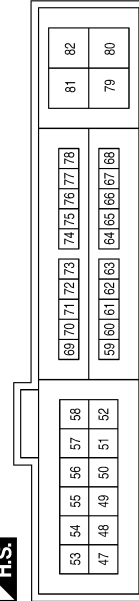

Terminal No.	72	Color of Wire	R/B	Signal Name	NP SW
--------------	----	---------------	-----	-------------	-------

Connector No.	E38
Connector Name	STOP LAMP SWITCH
Connector Color	WHITE



Terminal No.	Color of Wire	Signal Name
3	R	-
4	LG	-

ABMIA2106GB



# IPDM E/R (INTELLIGENT POWER DISTRIBUTION MODULE ENGINE ROOM)

< ECU DIAGNOSIS >

[POWER DISTRIBUTION SYSTEM]

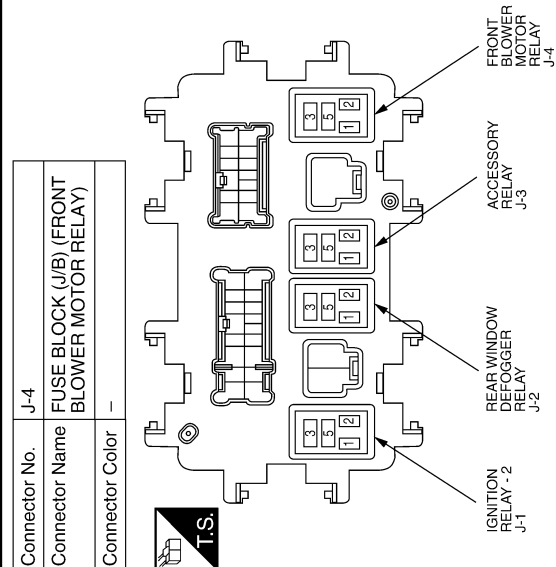
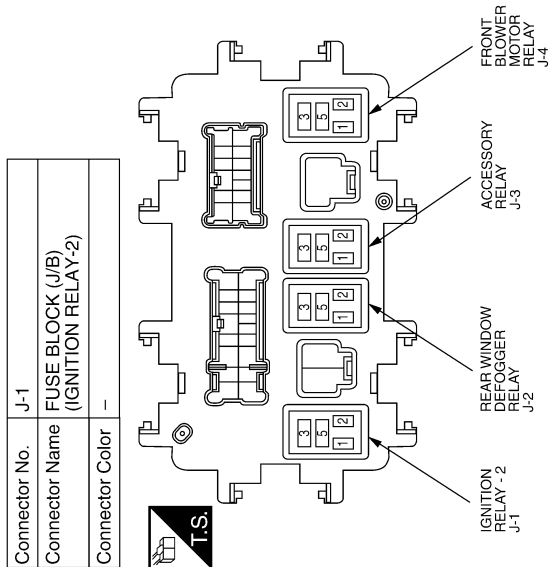
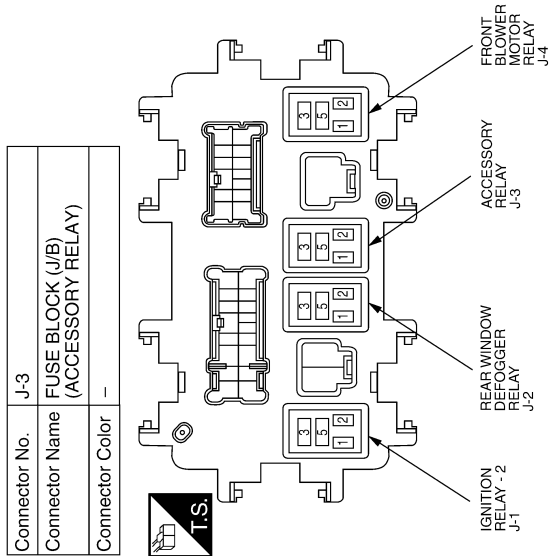

ABMIA2107GB

INFOID:000000005511888

## Fail Safe

### CAN COMMUNICATION CONTROL

When CAN communication with ECM and BCM is impossible, IPDM E/R performs fail-safe control. After CAN communication recovers normally, it also returns to normal control.

If No CAN Communication Is Available With ECM

A  
B  
C  
D  
E  
F  
G  
H  
I  
J  
K  
L  
M  
N  
O  
P

PCS

# IPDM E/R (INTELLIGENT POWER DISTRIBUTION MODULE ENGINE ROOM)

< ECU DIAGNOSIS >

[POWER DISTRIBUTION SYSTEM]

Control part	Fail-safe in operation
Cooling fan	<ul style="list-style-type: none"> <li>• Signals cooling fans ON when the ignition switch is turned ON</li> <li>• Signals cooling fans OFF when the ignition switch is turned OFF</li> </ul>
A/C compressor	A/C relay OFF
Generator	Outputs the power generation command signal (PWM signal) 0%

If No CAN Communication Is Available With BCM

Control part	Fail-safe in operation
Headlamp	<ul style="list-style-type: none"> <li>• Turns ON the headlamp low relay when the ignition switch is turned ON</li> <li>• Turns OFF the headlamp low relay when the ignition switch is turned OFF</li> <li>• Headlamp high relay OFF</li> </ul>
<ul style="list-style-type: none"> <li>• Parking lamps</li> <li>• License plate lamps</li> <li>• Illumination</li> <li>• Tail lamps</li> </ul>	<ul style="list-style-type: none"> <li>• Turns ON the tail lamp relay when the ignition switch is turned ON</li> <li>• Turns OFF the tail lamp relay when the ignition switch is turned OFF</li> </ul>
Front wiper	<ul style="list-style-type: none"> <li>• The status just before activation of fail-safe control is maintained until the ignition switch is turned OFF while the front wiper is operating at LO or HI speed.</li> <li>• The wiper is operated at LO speed until the ignition switch is turned OFF if the fail-safe control is activated while the front wiper is set in the INT mode and the front wiper motor is operating.</li> </ul>
Front fog lamps (if equipped)	Front fog lamp relay OFF
Horn	Horn OFF
Ignition relay	The status just before activation of fail-safe is maintained.
Starter motor	Starter control relay OFF
Electronic steering column lock <sup>1</sup>	Steering lock relay OFF

1: Early production

## IGNITION RELAY MALFUNCTION DETECTION FUNCTION

- IPDM E/R monitors the voltage at the contact circuit and excitation coil circuit of the ignition relay inside it.
- IPDM E/R judges the ignition relay error if the voltage differs between the contact circuit and the excitation coil circuit.
- If the ignition relay cannot turn OFF due to contact seizure, it activates the tail lamp relay for 10 minutes to alert the user to the ignition relay malfunction when the ignition switch is turned OFF.

DTC	Ignition switch	Ignition relay	Tail lamp relay
—	ON	ON	—
—	OFF	OFF	—
B2098: IGN RELAY ON	OFF	ON	ON (10 minutes)
B2099: IGN RELAY OFF	ON	OFF	—

### NOTE:

The tail lamp turns OFF when the ignition switch is turned ON.

## FRONT WIPER CONTROL

IPDM E/R detects front wiper stop position by a front wiper auto stop signal.

When a front wiper auto stop signal is in the conditions listed below, IPDM E/R stops power supply to wiper after repeating a front wiper 10 second activation and 20 second stop five times.

Ignition switch	Front wiper switch	Auto stop signal
ON	OFF	Front wiper stop position signal cannot be input 10 seconds.
	ON	The signal does not change for 10 seconds.

### NOTE:

# IPDM E/R (INTELLIGENT POWER DISTRIBUTION MODULE ENGINE ROOM)

< ECU DIAGNOSIS >

[POWER DISTRIBUTION SYSTEM]

This operation status can be confirmed on the IPDM E/R “Data Monitor” that displays “BLOCK” for the item “WIP PROT” while the wiper is stopped.

## STARTER MOTOR PROTECTION FUNCTION

IPDM E/R turns OFF the starter control relay to protect the starter motor when the starter control relay remains active for 90 seconds.

## DTC Index

INFOID:000000005511889

CONSULT-III display	Fail-safe	TIME <sup>NOTE</sup>		Refer to
No DTC is detected. further testing may be required.	—	—	—	—
U1000: CAN COMM CIRCUIT	×	CRNT	1 – 39	<a href="#">PCS-19</a>
B2098: IGN RELAY ON	×	CRNT	1 – 39	<a href="#">PCS-20</a>
B2099: IGN RELAY OFF	—	CRNT	1 – 39	<a href="#">PCS-21</a>
B2108: STRG LCK RELAY ON	—	CRNT	1 – 39	<a href="#">SEC-92</a>
B2109: STRG LCK RELAY OFF	—	CRNT	1 – 39	<a href="#">SEC-93</a>
B210A: STRG LCK STATE SW	—	CRNT	1 – 39	<a href="#">SEC-94</a>
B210B: START CONT RLY ON	—	CRNT	1 – 39	<a href="#">SEC-98</a>
B210C: START CONT RLY OFF	—	CRNT	1 – 39	<a href="#">SEC-99</a>
B210D: STARTER RELAY ON	—	CRNT	1 – 39	<a href="#">SEC-100</a>
B210E: STARTER RELAY OFF	—	CRNT	1 – 39	<a href="#">SEC-101</a>
B210F: INTRLCK/PNP SW ON	—	CRNT	1 – 39	<a href="#">SEC-103</a>
B2110: INTRLCK/PNP SW OFF	—	CRNT	1 – 39	<a href="#">SEC-105</a>

### NOTE:

The details of TIME display are as follows.

- CRNT: The malfunctions that are detected now
- 1 - 39: The number is indicated when it is normal at present and a malfunction was detected in the past. It increases like 0 → 1 → 2 ... 38 → 39 after returning to the normal condition whenever IGN OFF → ON. It is fixed to 39 until the self-diagnosis results are erased if it is over 39. It returns to 0 when a malfunction is detected again in the process.

PCS

# POWER DISTRIBUTION SYSTEM SYMPTOMS

< SYMPTOM DIAGNOSIS >

[POWER DISTRIBUTION SYSTEM]

## SYMPTOM DIAGNOSIS

### POWER DISTRIBUTION SYSTEM SYMPTOMS

#### Symptom Table

INFOID:000000005460663

Before performing the diagnosis in the following table, check the contents of [PCS-42, "Work Flow"](#).

Symptom	Suspect Systems	Refer to
The power supply changing operation is normal, but the push-button ignition switch position indicator does not turn on.	1. Check push-button ignition switch position indicator.	<a href="#">PCS-75</a>
	2. Check Intermittent Incident.	<a href="#">GI-39</a>

< PRECAUTION >

PRECAUTION

PRECAUTIONS

Precaution for Supplemental Restraint System (SRS) "AIR BAG" and "SEAT BELT PRE-TENSIONER"

INFOID:000000005460664

The Supplemental Restraint System such as "AIR BAG" and "SEAT BELT PRE-TENSIONER", used along with a front seat belt, helps to reduce the risk or severity of injury to the driver and front passenger for certain types of collision. This system includes seat belt switch inputs and dual stage front air bag modules. The SRS system uses the seat belt switches to determine the front air bag deployment, and may only deploy one front air bag, depending on the severity of a collision and whether the front occupants are belted or unbelted. Information necessary to service the system safely is included in the SR and SB section of this Service Manual.

**WARNING:**

- To avoid rendering the SRS inoperative, which could increase the risk of personal injury or death in the event of a collision which would result in air bag inflation, all maintenance must be performed by an authorized NISSAN/INFINITI dealer.
- Improper maintenance, including incorrect removal and installation of the SRS, can lead to personal injury caused by unintentional activation of the system. For removal of Spiral Cable and Air Bag Module, see the SR section.
- Do not use electrical test equipment on any circuit related to the SRS unless instructed to in this Service Manual. SRS wiring harnesses can be identified by yellow and/or orange harnesses or harness connectors.

PRECAUTIONS WHEN USING POWER TOOLS (AIR OR ELECTRIC) AND HAMMERS

**WARNING:**

- When working near the Airbag Diagnosis Sensor Unit or other Airbag System sensors with the Ignition ON or engine running, DO NOT use air or electric power tools or strike near the sensor(s) with a hammer. Heavy vibration could activate the sensor(s) and deploy the air bag(s), possibly causing serious injury.
- When using air or electric power tools or hammers, always switch the Ignition OFF, disconnect the battery, and wait at least 3 minutes before performing any service.

Precautions Necessary for Steering Wheel Rotation after Battery Disconnect (Early Production, With Electronic Steering Column Lock)

INFOID:000000005885967

**NOTE:**

- Before removing and installing any control units, first turn the push-button ignition switch to the LOCK position, then disconnect both battery cables.
- After finishing work, confirm that all control unit connectors are connected properly, then re-connect both battery cables.
- Always use CONSULT-III to perform self-diagnosis as a part of each function inspection after finishing work. If a DTC is detected, perform trouble diagnosis according to self-diagnosis results.

This vehicle is equipped with a push-button ignition switch and a steering lock unit.

If the battery is disconnected or discharged, the steering wheel will lock and cannot be turned.

If turning the steering wheel is required with the battery disconnected or discharged, follow the procedure below before starting the repair operation.

OPERATION PROCEDURE

1. Connect both battery cables.

**NOTE:**

Supply power using jumper cables if battery is discharged.

2. Carry the Intelligent Key or insert it to the key slot and turn the push-button ignition switch to ACC position. (At this time, the steering lock will be released.)
3. Disconnect both battery cables. The steering lock will remain released with both battery cables disconnected and the steering wheel can be turned.
4. Perform the necessary repair operation.

A  
B  
C  
D  
E  
F  
G  
H  
I  
J  
K  
L  
N  
O  
P

PCS

## PRECAUTIONS

< PRECAUTION >

[POWER DISTRIBUTION SYSTEM]

5. When the repair work is completed, re-connect both battery cables. With the brake pedal released, turn the push-button ignition switch from ACC position to ON position, then to LOCK position. (The steering wheel will lock when the push-button ignition switch is turned to LOCK position.)
6. Perform self-diagnosis check of all control units using CONSULT-III.

### Precaution for Procedure without Cowl Top Cover

INFOID:000000005460666

When performing the procedure after removing cowl top cover, cover the lower end of windshield with urethane, etc.

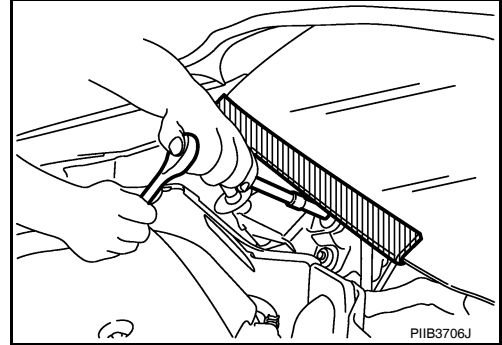

**ON-VEHICLE REPAIR**

BCM (BODY CONTROL MODULE)

Removal and Installation

INFOID:000000005460667

For removal and installation of the BCM, refer to [BCS-87, "Removal and Installation"](#).

- A
- B
- C
- D
- E
- F
- G
- H
- I
- J
- K
- L
- PCS
- N
- O
- P

# PUSH BUTTON IGNITION SWITCH

< ON-VEHICLE REPAIR >

[POWER DISTRIBUTION SYSTEM]

## PUSH BUTTON IGNITION SWITCH

### Removal and Installation

INFOID:000000005460668

#### REMOVAL

1. Remove the cluster lid A assembly. Refer to [IP-12. "Removal and Installation"](#).
2. Release the pawls (A) and remove the push-button ignition switch (1) from cluster lid A.

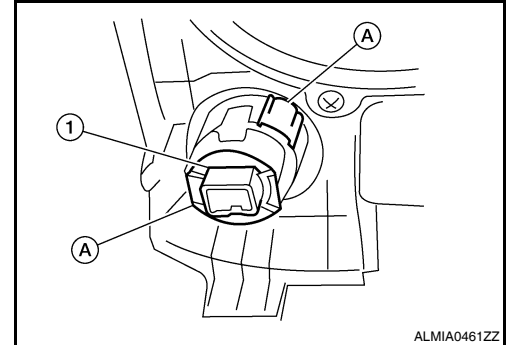

ALMIA0461ZZ

#### INSTALLATION

Installation is in the reverse order of removal.